

CONTENTS

I) Laboratory Glassware

Beakers	2
Bottles	3
Bottles, Screw Caps, Pouring Rings	4
Screw Caps	5
Wide Neck Lab Bottles	6
Reagent Bottles	9
Aspirator Bottles	11
Weighing Bottles, Dropping Bottles	12
BOD Bottles, Specific Gravity Bottles	13
Pathological Bottles, Jars, Vials	14

II) Volumetric Glassware

Burettes	15
Automatic Burettes	19
Reservoir Bottles	22
Micro Burettes	23
Counting Chambers, Cover Glass	24
Microscope Slides, Cover Slips	25
Cover Glass	26
Desiccators	27
Stopcock, Petri Dishes	28
Erlenmeyer Flasks	30
Flasks	31
Filtering Flasks	32
Volumetric Flasks	33
Filter Crucibles	35
Filter Head, Filter Funnels	36
Funnels	37
Filtration Assembly	39
Glass Stoppers, Haemocytometer Set	40
Measuring Cylinders	41
Graduated Pipettes	43
Volumetric Pipettes	44
Pasteur Pipettes	45
Water Jet Pumps, Quartz Cell, Glass Cell	46
Haematocrit Tubes, Minicaps	47
Capillary Tubes	48
Staining Jar	49
Test Tubes	50
Centrifuge Tubes	51

III) Interchangeable Glassware

Adapters	54
Dreschel Bottle Head, Washing Bottles	59
Cold Traps	60
Chromatography Columns	61
Condensers	63
Soxhlet Extractors, Filter Funnels	65
Reaction Flasks	66
Jacketed Reaction Vessels	67
Flasks	68
Recovery Bends	77
Glass Stoppers, Stirrers	79
Test Tubes	80
Extraction Apparatus & Assembly	82
Kjeldahl Distillation Assembly	83
Absorption Traps, Markham Distillation	84
Chromatography Apparatus	85

IV) Plasticware

Micro Centrifuge Tubes	87
Square Cuvettes	87
Pipette Tips	87
Disposable Petri Dish	87

V) Paper Product

Filtres Fioroni	91
Membrane Solution	95
Favorit Extraction Thimble	95.1

VI) Scientific Equipment

All American	96
Brand	97
CDR	98
Daihan Scientific	99
Denver Instrument	108
ENC	109
Favorit®	110
Gyrozen	112
Haier	118
Hirschmann	120
KNF	121
Kudos	122
Labwit	133
Longer pump	126
Mirae	129
MMM	130
Rocker Scientific	132
Trans Instrument	136
Trefflab	138
Velp	139
Vitlab	141
Yamato	142

VII) Miscellaneous 143

VIII) Others

Brush	144
Thermometer	145
Hydrometer	146

DURAN, GERMANY

BEAKERS, Low Form with graduation and spout DIN 12331, ISO 3819 with Retrace Code	Catalogue Number	Capacity ml
	2110607 ¹	5
	2110608 ¹	10
	2110614	25
DURAN, GERMANY	2110617	50
	2110624	100
	2110629	150
	2110636	250
	2110641	400
	2110644	500
	2110648	600
	2110653	800
	2110654	1000
	2110663	2000
	2110668	3000
	2110673	5000
1 : without graduation 2 : non-DIN, non-ISO size	2110686 ^{1,2}	10000



BEAKERS, Tall Form with Spout with graduation DIN 12331, ISO 3819 with Retrace Code	Catalogue Number	Capacity ml
	2111617	50
	2111624	100
	2111629	150
	2111636	250
DURAN, GERMANY	2111641	400
	2111648	600
	2111653	800
	2111654	1000
	2111663	2000
	2111668	3000



BEAKERS, Tall Form without Spout with graduation with Retrace Code	Catalogue Number	Capacity ml
	2111717	50
	2111724	100
	2111729	150
DURAN, GERMANY	2111736	250
	2111741	400
	2111748	600
	2111754	1000



BEAKERS, Heavy Wall with graduation and spout (filtering beaker)	Catalogue Number	Capacity ml
	2113124	100
	2113129	150
DURAN, GERMANY	2113136	250
	2113144	500
	2113154	1000
	2113163	2000
	2113168	3000
	2113173	5000
	2113186 ¹	10000
	2113188 ¹	15000
1 : without graduation	2113191 ¹	20000



BEAKERS, Philips with spout	Catalogue Number	Capacity ml
	2114129	150
DURAN, GERMANY	2114136	250
	2114144	500



BEAKER, Berzelius	Catalogue Number	Capacity ml	O.D. mm	Height mm
DURAN, GERMANY	2112601	100	50	78

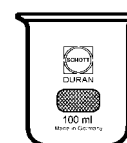

DURAN, GERMANY



LABORATORY BOTTLES
with DIN Thread, graduated
c/w blue PP screw-cap
and pouring ring
ISO 4796

with Retrace Code

DURAN, GERMANY

Note :
Bottles, pouring rings and screw
caps can be sterilised.

Important :
During sterilisation, the screw caps
should be left loose.
(not more than one turn)
to avoid setting up
differential pressure
which could break the glass.

When freezing, place the bottles
at an angle (approx. 45 deg.)
and do not fill to more than
3/4 capacity
(increased surface area).

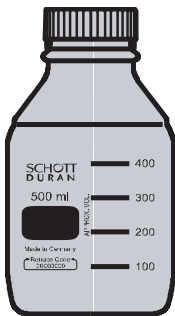

Catalogue Number	Capacity ml	DIN Thread
Laboratory Bottles		
21801145 ²	25	GL 25
21801175	50	GL 32
21801245	100	GL 45
21801365	250	GL 45
21801445	500	GL 45
21801545	1000	GL 45
21801635	2000	GL 45
21801735	5000	GL 45
21801865	10000	GL 45
21801885	15000	GL 45
21801915	20000	GL 45

Catalogue Number	Capacity ml	DIN Thread
Amber Laboratory Bottles		
21806145 ²	25	GL 25
21806175	50	GL 32
21806245	100	GL 45
21806365	250	GL 45
21806445	500	GL 45
21806545	1000	GL 45
21806635	2000	GL 45
21806735	5000	GL 45
21806865	10000	GL 45
21806885	15000	GL 45
21806915	20000	GL 45

2 : Bottle with specially formed glass lip for better pouring.
This makes an additional plastic pouring ring unnecessary.



SQUARE BOTTLES
with DIN Thread, graduated
c/w blue PP screw-cap
and pouring ring
ISO 4796
with Retrace Code
DURAN, GERMANY

Catalogue Number	Capacity ml	DIN Thread
Square Laboratory Bottles		
21820245	100	GL 32
21820365	250	GL 45
21820445	500	GL 45
21820545	1000	GL 45



LABORATORY BOTTLES
Plastic Coated (PU)
with DIN Thread,
without cap and pouring ring
ISO 4796
with Retrace Code

DURAN, GERMANY

Catalogue Number	Capacity ml	DIN Thread
1092676	25	GL 25
1092677	50	GL 32
2180524	100	GL 45
2180536	250	GL 45
2180544	500	GL 45
2180554	1000	GL 45
2180563	2000	GL 45
2180573	5000	GL 45
2180586	10000	GL 45
2180591	20000	GL 45



LABORATORY BOTTLES
Pressure Plus
with DIN Thread,
without cap and pouring ring
pressure resistant -1/+1.5 bar
ISO 4796
blue graduation
with Retrace Code

DURAN, GERMANY

Catalogue Number	Capacity ml	DIN Thread
Clear Bottles		
1092234	250	GL 45
1092235	500	GL 45
2181054	1000	GL 45
Amber Bottles		
1094367	250	GL 45
1094368	500	GL 45
2181654	1000	GL 45

DURAN, GERMANY

LABORATORY BOTTLES Premium Bottle	Catalogue Number	Capacity ml	DIN Thread
with DIN Thread,	1127075	100	GL 45
c/w blue screw-cap(TpCh 260)	1127076	250	GL 45
and pouring ring	1127077	500	GL 45
thermal shock resistance 160K	1127078	1000	GL 45
DIN ISO 718, with Retrace Code			
DURAN , GERMANY			

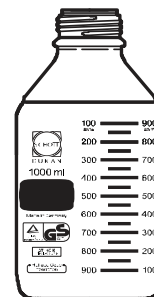

LABORATORY BOTTLES HPLC Bottle	Catalogue Number	Capacity ml	DIN Thread
with DIN Thread,	1129821	500	GL 45
c/w 4 port blue PP screw-cap	1129820	1000	GL 45
and seals	Accessory		
pressure resistance -1/+1.5bar	1129812	4 Port Screw Cap HPLC, GL45	
with Retrace Code	1129813	Spare part set for HPLC Screw Cap	
	1137801	Pressure Equalization Set for 4-Port Cap (0.2µm incl. Membrane Filter)	
DURAN , GERMANY	1129819	Spare Membrane Filter	



PP SCREW-CAPS, Blue	Catalogue Number	DIN Thread
with lip seal	2923913	GL 25
autoclavable up to 140°C steam	2923919	GL 32
DURAN , GERMANY	2923928	GL 45

PP POURING RINGS, Blue	Catalogue Number	For DIN Thread
autoclavable up to 140°C steam	2924219	GL 32
DURAN , GERMANY	2924228	GL 45

PBT SCREW-CAPS, Red	Catalogue Number	DIN Thread
c/w PTFE protected seal,	2924008	GL 14
to withstand up to 180°C	2924011	GL 18
DURAN , GERMANY	2924013	GL 25
	2924019	GL 32
	2924028	GL 45

ETFE POURING RINGS, Red	Catalogue Number	For DIN Thread
to withstand up to 180°C	2924419	GL 32
DURAN , GERMANY	2924428	GL 45

PREMIUM SCREW-CAPS, Colourless	Catalogue Number	DIN Thread
made of TpCH260 with seal	1088679	GL 45
Temp resistant -196°C to +260°C		
hot-air sterilization		
USP/FDA standard conformity		
DURAN , GERMANY		

PREMIUM POURING RING, Colourless	Catalogue Number	For DIN Thread
made of TpCH260	1088678	GL 45
DURAN , GERMANY		

PP MEMBRANE SCREW-CAPS, Blue	Catalogue Number	For DIN Thread
welded-in PTFE membrane	1183250	GL 25
for pressure equalisation	1183251	GL 32
temp. resistant to 140° C and autoclavable up to 121° C	1088655	GL 45
DURAN , GERMANY		



DURAN, GERMANY



**PP TAMPER-EVIDENT
SCREW CAPS, BLUE-RED**
for laboratory bottles
with lip seal
autoclavable up to 140° C steam
with DIN thread
ISO 4796
DURAN , GERMANY

Catalogue Number	DIN Thread
1017526	GL 45

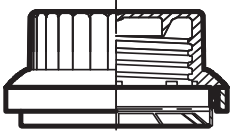

**PP TAMPER-EVIDENT
SCREW CAPS, BLUE-YELLOW**
for laboratory bottles
with PTFE silicone seal
autoclavable up to 140° C steam
with DIN thread
ISO 4796
DURAN , GERMANY

Catalogue Number	DIN Thread
1155886	GL 45

MULTIPOINT-SYSTEM
screw cap **GL45** with
2 or 3 ports (GL14 Thread)
Flexible modular system

temp. resistant max. to 140° C
autoclavable up to 121° C

DURAN , GERMANY



Catalogue Number	DIN Thread
GL 45 Screw Cap with 2 ports (GL 14 Thread)	

1129750 GL 45

GL 45 Screw Cap with 3 ports (GL14 Thread)

1129751 GL 45

Screw cap GL14 for tube connection

1129814 GL 14

Insert for screw cap GL14, ID 1.6mm

1129815

Insert for screw cap GL14, ID 3.0mm

1129816

Insert for screw cap GL14, ID 3.2mm

1129817

Insert for screw cap GL14, ID 6.0mm

1129818

RED Screw cap, PBT, with PTFE coated seal GL14

1156292 GL 14

Pressure equalisation set for 2 & 3-port, GL 14

1137799

Spare membrane filter 0.2 µm

1129819

GLS 80 CONNECTION SYSTEM
screw cap GLS 80 with
four ports (GL 18 thread)

temp. resistant max. to 140° C
autoclavable up to 121° C

DURAN , GERMANY



Catalogue Number	DIN Thread
GLS 80 screw cap with 4 ports (GL 18 Thread)	

1160176 GLS 80

Insert for screw cap GL 18, ID 3.2mm

1160169

Insert for screw cap GL 18, ID 6.0mm

1160170

Insert for screw cap GL 18, ID 8.0mm

1160171

Insert for screw cap GL 18, ID 10.0mm

1160172

Insert for screw cap GL 18, ID 12.0mm

1160173

BLUE Screw Cap for tube connection, GL 18

1160174

Pressure equalisation set for 4-port, GL 18

1160167

RED Screw Cap, PBT, GL 18

1170682

DURAN, GERMANY



GLS80 STIRRED REACTOR

suitable for a wide range of laboratory mixing processes

The whole assembly can be autoclaved and is therefore suitable for use in the Biological Sector.

use up to 500 rpm is possible

Typical applications :
mixing of liquids, dissolving of solids, simple fermentation processes

Catalogue Number	Thread GLS	Anchor Stirrer d (mm)
1200379	80	62
Stirred reactor cap, stirrer anchor type, magnetic, c/w shaft, connector and screw cap		
1200380	80	62
Stirred reactor anchor type, magnetic, c/w DURAN GLS80 bottle 1000ml, GL14 Screw Cap (PP, Blue), 2 x GL14 Screw Cap (PBT, Red), 2 x GL18 Screw Cap (PBT, Red)		
1200381	80	62
Stirred reactor anchor type, magnetic, c/w DURAN GLS80 bottle 2000ml, GL14 Screw Cap (PP, Blue), 2 x GL14 Screw Cap (PBT, Red), 2 x GL18 Screw Cap (PBT, Red)		

Accessories for GLS80 Stirred Reactor

1200382	Stirrer impeller type 62mm diameter, magnetic, for GLS80 stirred reactor	
1200383	Stirrer anchor type 62mm diameter, magnetic, for GLS80 stirred reactor	
1200385	Spare screw cap for GLS80 stirred reactor, PP, Blue/Grey	
1200386	Spare shaft for GLS80 stirred reactor, stainless steel, including PEEK connection	



DG SAFETY CAPS

screw cap GL 45 with one, two or three ports

Typical applications :
safe transfer of aggressive media within a closed system (evaporation is reduced)

Catalogue Number	Description
1168401	DG Safety Cap I (1 port)
1168402	DG Safety Cap II (2 ports)
1168413	DG Safety Cap III (3 ports)
1168414	DG Safety Cap I with stopcock
1168415	DG Safety Cap II with stopcock
1168416	DG Safety Cap III with stopcock

c/w GL45 screw cap, connection screws, conical nipple(id 3.2mm),ventilation valve & membrane filter



Catalogue Number	Description
1168417	DG Safety Cap for NS 29/32 c/w screw cap for NS29/32, connection screws, conical nipple(id 3.2mm),ventilation valve & membrane filter



DG SAFETY WASTE CAPS

additional connection option for activated carbon filter and leak hose, GL 45

Typical applications :
safe storage and collection of liquid laboratory waste

Catalogue Number	Description
1168418	DG Safety Waste Cap c/w GL45 screw cap, connection screws and conical nipple(id 3.2mm, PTFE)
1168420	DG Safety Waste Cap for leak hose c/w GL45 screw cap, connection screws, conical nipple(id 3.2mm, PTFE) & connection for leak hose

DURAN, GERMANY

SCREW CAP with Apperture, PBT, Red	Catalogue Number	DIN Thread GL	Aperture Bore mm
typical applications:	2922705	14	9.5
Injection or removal of media	2922706	18	11
temp. resistant 180°C	2922709	25	15
autoclavable up to 121° C	2922708	32	20
	2922710	45	34

DURAN , GERMANY



SILICONE SEAL (SPETA) VMQ, for piercing	Catalogue Number	for DIN Thread, GL	Diameter mm	Thickness mm
typical applications:	2924605	14	12	2
Injection or removal of media	2924606	18	16	2
	2924609	25	22	2
DURAN , GERMANY	2924608	32	29	2
	2924610	45	42	3

DURAN , GERMANY



SILICONE SEALING RING VMQ with bonded PTFE face	Catalogue Number	for DIN Thread, GL	OD x ID mm	for Tube Ø mm
Suitable for PBT Screw Cap with Aperture	2923406	14	12 x 6	5.5 - 6.5
Heat resistance :	2923506	18	16 x 6	5.5 - 6.5
* 130°C (vapour)	2923508	18	16 x 8	7.5 - 9.0
* 200°C (dry heat)	2923510	18	16 x 10	9.0 - 11.0
typical applications:	2923708	25	22 x 8	7.5 - 9.0
fixing of tubes	2923710	25	22 x 10	9.0 - 11.0
	2923712	25	22 x 12	11.0 - 13.0
DURAN , GERMANY	2923610	32	29 x 10	9.0 - 11.0
	2923612	32	29 x 12	11.0 - 13.0
	2923614	32	29 x 14	13.0 - 15.0
	2923616	32	29 x 16	15.0 - 17.0
	2923618	32	29 x 18	17.0 - 19.0
	2923826	45	42 x 26	25.0 - 27.0
	2923832	45	42 x 32	31.0 - 33.0

DURAN , GERMANY



SILICONE SEAL PTFE Coated (VMQ)	Catalogue Number	for Screw Cap, Red GL
Suitable for PBT Screw Cap, Premium & Tamper-Evident Screw Cap.	2924808	14
Heat resistance :	2924811	18
* 130°C (vapour)	2924813	25
* 200°C (dry heat)	2924819	32
	2924828	45

Good chemical resistance due to PTFE coating.

DURAN , GERMANY



DURAN, GERMANY



REAGENT BOTTLES, Wide Neck Glass Stopper Made of Borosilicate Glass ISO 4796-2	Catalogue Number	Capacity ml
DURAN , GERMANY	Clear Glass	
	2118517	50
	2118524	100
	2118536	250
	2118544	500
	2118554	1000
	2118563	2000
	2118573	5000
	2118586	10000
	2118591	20000
	Amber Glass	
	2118817	50
	2118824	100
	2118836	250
	2118844	500
	2118854	1000
	2118863	2000
	2118873	5000
	2118886	10000
2118891	20000	



REAGENT BOTTLES, Wide Neck Glass Stopper Made of Soda Lime ISO 4796-2	Catalogue Number	Capacity ml
DURAN , GERMANY	Clear Glass	
	2318517	50
	2318524	100
	2318536	250
	2318544	500
	2318554	1000
	Amber Glass	
	2318824	100
	2318836	250
	2318844	500
2318854	1000	

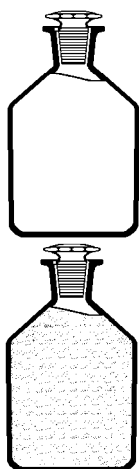

REAGENT BOTTLES, Narrow Neck Glass Stopper Made of Soda Lime ISO 4796-2	Catalogue Number	Capacity ml
DURAN , GERMANY	Clear Glass	
	2316517 #	50
	2316524	100
	2316536	250
	2316544	500
	2316554	1000
	Amber Glass	
	2316817	50
	2316824	100
	2316836	250
2316844	500	
2316854	1000	

Available until stocks are exhausted

BOECKEL, GERMANY

REAGENT BOTTLES, Narrow Neck Glass Stopper Made of Soda Lime	Catalogue Number	Capacity ml
	Clear Glass	
	GLA414102050	50
	GLA414102100	100
	GLA414102250	250
	GLA414102500	500
	GLA 414102940	1000
	GLA 414102950	2000
Amber Glass		
	GLA414202050	50
	GLA414202100	100
	GLA414202250	250
	GLA414202500	500
	GLA414202940	1000
	GLA414202950	2000

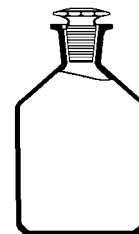

REAGENT BOTTLES, Wide Neck Glass Stopper Made of Soda Lime	Catalogue Number	Capacity ml
	Clear Glass	
	GLA414104050	50
	GLA414104100	100
	GLA414104250	250
	GLA414104500	500
	GLA414104940	1000
	GLA414104950	2000
Amber Glass		
	GLA414204050	50
	GLA414204100	100
	GLA414204250	250
	GLA414204500	500
	GLA414204940	1000
	GLA414204950	2000



DURAN, GERMANY



ASPIRATOR BOTTLES NS Tubulated c/w NS stopcock and stopper	Catalogue Number	Capacity ml	Neck
	2470244	500	24/29
	2470254	1000	29/32
	2470263	2000	29/32
	2470273	5000	45/40
DURAN , GERMANY	2470286	10000	60/46
	2470291	20000	60/46

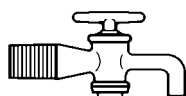

STOPCOCK NS for Aspirator Bottles	Catalogue Number	Capacity ml	NS
	2414803	500 - 2000	19/26
DURAN , GERMANY	2414804	5000 - 20000	29/32



ASPIRATOR BOTTLES Neck with GL45 DIN Screwthread	Catalogue Number	Capacity ml	DIN thread
tabulator with GL 32	2470354	1000	GL 45
	2470363	2000	GL 45
	2470373	5000	GL 45
	2470386	10000	GL 45

DURAN , GERMANY

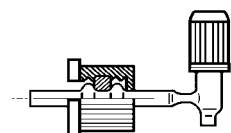

DRAINCOCK with PTFE Spindle for GL 32 DIN Screwthread for Aspirator Bottle c/w screwthread adapter coupling and silicone gasket	Catalogue Number	Capacity ml
	2414703	1000 & 2000
	2414704	5000 & 10000

DURAN , GERMANY

DURAN, GERMANY

WEIGHING BOTTLES, Flat Shape with grip stopper	Catalogue Number	Capacity ml	O.D. X Height mm
	2421013	5	28 x 25
2421023	15	38 x 30	
DURAN , GERMANY	2421032	30	54 x 30
	2421041	80	85 x 30



WEIGHING BOTTLES, Tall Shape with grip stopper	Catalogue Number	Capacity ml	O.D. X Height mm
	2421113	10	28 x 40
2421118	20	32 x 50	
DURAN , GERMANY	2421123	45	38 x 70
	2421124	70	44 x 80

WEIGHING BOTTLE with Ground Joint 50/14	Catalogue Number	Description	Capacity ml
	JWB50 L	Lid	---
FAVORIT , MALAYSIA	JWB50 B	Base	58

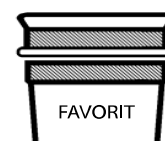

DROPPING BOTTLES with Interchangeable Pipette NS and Rubber Teats	Catalogue Number	Capacity ml
	Clear Dropping Bottles	
Soda-lime glass	2327017	50
	2327024	100
DURAN , GERMANY	Amber Dropping Bottles	
	23270176	50
	23270246	100
Accessories		
2327117	Pipette for 50ml Bottle, Clear Glass	
2327124	Pipette for 100ml Bottle, Clear Glass	
2920001	Rubber Teat, Transparent	



DROPPING BOTTLES with Flat Stopper	Catalogue Number	Capacity ml
	Clear Dropping Bottles	
DURAN , GERMANY	2327215	30
	Amber Dropping Bottles	
Note : Available until stocks are exhausted.	23272156	30
	23272246	100



CLARITY BOWL with Rubber Stopper & Tubing	Catalogue Number	Description	Capacity ml
	FAVORIT , MALAYSIA	P805101	

**300ML BOD BOTTLE
and Accessory**

WHEATON , USA

Catalogue Number	Capacity ml
Clear	
WH227497-01	300
WH227723	Plastic Cap & Foam Insert
Amber	
WH227667	300

300ML BOD BOTTLE

FAVORIT , MALAYSIA

Catalogue Number	Capacity ml
Clear	
P808497	300
P808498	Glass Robotic B.O.D. Stopper

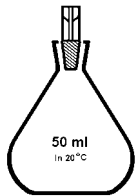
**SPECIFIC GRAVITY BOTTLES
Precisely Calibrated**

LENZ , GERMANY

Catalogue Number	Capacity ml
LL5.6302.13	10
LL5.6302.22	25
LL5.6302.28	50
LL5.6302.37	100

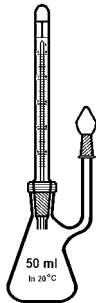
**SPECIFIC GRAVITY BOTTLES
with Interchangeable
Thermometer**

Precisely Calibrated

LENZ , GERMANY

Catalogue Number	Capacity ml
LL5.6400.13	10
LL5.6400.22	25
LL5.6400.28	50
LL5.6400.37	100

**SPECIFIC GRAVITY BOTTLES
Precisely Calibrated**

BRAND , GERMANY

Note : Available until stocks
are exhausted.

Catalogue Number	Capacity ml
BD43338	100

**SPECIFIC GRAVITY BOTTLES
with Interchangeable
Thermometer**

Precisely Calibrated

Note : Available until stocks
are exhausted.

BRAND , GERMANY

Catalogue Number	Capacity ml
BD43420	25
BD43428	50

FAVORIT, MALAYSIA

PATHOLOGICAL BOTTLES Autoclavable with aluminium screw cap fitted with rubber liner	Catalogue Number	Capacity ml	
	P808101	Bijou	7
P808102	Mc Cartney	14	
P808103	Mc Cartney	28	
FAVORIT , MALAYSIA	P808104	Universal	28



S.MURRAY, U.K.

POWDER JARS, Tall Form (Beatson Type) Wide Mouth with black screw cap	Catalogue Number	Diameter X Height mm		Capacity ml
	Clear			
S. MURRAY , U.K.	G805/02	39	59	30
	G805/03	45	76	60
	G805/05	54	95	120
	G805/07	64	119	250
	G805/08	83	150	500
Amber				
	G805/A2	39	59	30
	G805/A3	45	76	60
	G805/A5	54	95	120
	G805/A7	64	119	250
	G805/A8	83	150	500



OINTMENT JARS, Squat Form, Clear (Beatson Type) Extra Wide Mouth with black screw cap	Catalogue Number	Diameter X Height mm		Capacity ml
	S. MURRAY , U.K.	G806/02	41	46
	G806/03	52	52	60
	G806/04	62	63	120
	G806/06	86	73	250
	G806/07	110	84	500



SCREW NECK VIALS "Trident" Tall Form with black screw cap	Catalogue Number	Capacity		Size mm
		Dram	ml	
S. MURRAY , U.K.	T101/V1	0.5	1.75	36 x 11
	T101/V2	1	3.5	46 x 12.5
	T101/V3	2	7	58 x 17
	T101/V4	3	10.5	67 x 17
	T101/V5	4	14	72 x 20
	T101/V6	6	21.25	86 x 21
	T101/V7	8	28.25	96 x 23

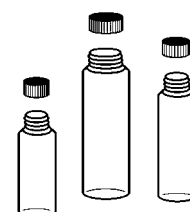

SCREW NECK VIALS "Trident" Squat Form with black screw cap	Catalogue Number	Capacity		Size mm
		Dram	ml	
S. MURRAY , U.K.	T102/V1	2	7.0	42 x 20
	T102/V2	4	14	58 x 23.25
	T102/V3	8	28.25	72 x 27.5



WHEATON, USA

SCINTILLATION VIALS Low Potassium Glass with screw cap	Catalogue Number	Capacity ml	Size mm
	WHEATON , USA	WH986542	20

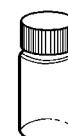

FAVORIT, MALAYSIA



BURETTES, Class AS, PTFE Key Schellbach	Catalogue Number	Volume ml	Division ml	Tolerance +/- ml
	P806310	10	0.02	0.02
	P806325	25	0.05	0.03
FAVORIT , MALAYSIA	P806350	50	0.1	0.05

BURETTES, Class B with Straight PTFE Stopcock	Catalogue Number	Volume ml	Division ml	Tolerance +/- ml
	P806210	10	0.05	
FAVORIT , MALAYSIA	P806225	25	0.1	
	P806250	50	0.1	

BURETTES, Class B with Plug-In PTFE Stopcock	Catalogue Number	Volume ml	Division ml	Tolerance +/- ml
FAVORIT , MALAYSIA	P806150	50	0.1	

HIRSCHMANN, GERMANY



BURETTES, Class AS, PTFE Key Schellbach, blue graduation	Catalogue Number	Volume ml	Division ml	Tolerance +/- ml
main point ring graduation	314026029	10	0.02	0.02
DIN EN ISO 385	314027029	25	0.05	0.03
	314027529	50	0.1	0.05

HIRSCHMANN , GERMANY

Note : Available until stocks are exhausted.

BURETTES, Class AS, Glass Key Schellbach, blue graduation	Catalogue Number	Volume ml	Division ml	Tolerance +/- ml
main point ring graduation	314016029	10	0.02	0.02
DIN EN ISO 385	314017029	25	0.05	0.03
	314017529	50	0.1	0.05

HIRSCHMANN , GERMANY

Note : Available until stocks are exhausted.

HIRSCHMANN, GERMANY

**BURETTES, Class AS,
Straight Valve Stopcock with
PTFE Spindle, CC**
Schellbach, blue graduation
DIN EN ISO 385

Catalogue Number	Volume ml	Division ml	Tolerance +/- ml
3140260	10	0.02	0.02
3140270	25	0.05	0.03
3140275	50	0.1	0.05

CERTIFICATES OF PERFORMANCE

9980101	Batch Certificate
9980102	Individual Certificate

HIRSCHMANN, GERMANY



**BURETTES, Class AS, PTFE Key
Conformity Certified,
with Dated Batch Identification**
Schellbach, blue graduation
main point ring graduation
DIN EN ISO 385

Catalogue Number	Volume ml	Division ml	Tolerance +/- ml
3140360	10	0.02	0.02
3140370	25	0.05	0.03
3140375	50	0.1	0.05

CERTIFICATES OF PERFORMANCE

9980101	Batch Certificate
9980102	Individual Certificate

HIRSCHMANN, GERMANY

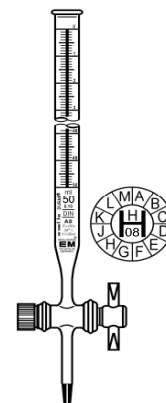

**BURETTES, Class AS, Glass Key
Conformity Certified,
with Dated Batch Identification**
Schellbach, blue graduation
main point ring graduation
DIN EN ISO 385

Catalogue Number	Volume ml	Division ml	Tolerance +/- ml
3140160	10	0.02	0.02
3140170	25	0.05	0.03
3140175	50	0.1	0.05

CERTIFICATES OF PERFORMANCE

9980101	Batch Certificate
9980102	Individual Certificate

HIRSCHMANN, GERMANY

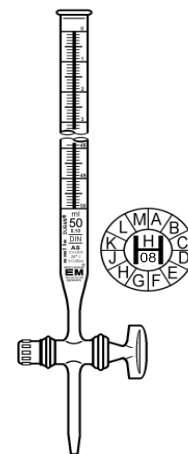

**BURETTES, Class AS, Glass Key
Conformity Certified,
with Dated Batch Identification**
amber stain graduation
main point ring graduation
DIN EN ISO 385

Catalogue Number	Volume ml	Division ml	Tolerance +/- ml
3130160	10	0.02	0.02
3130170	25	0.05	0.03
3130175	50	0.1	0.05

CERTIFICATES OF PERFORMANCE

9980101	Batch Certificate
9980102	Individual Certificate

HIRSCHMANN, GERMANY

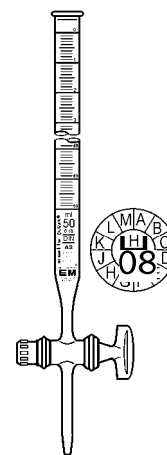

**BURETTES, Class AS, Glass Key
Amber Glass
Conformity Certified,
with Dated Batch Identification**
main point ring graduation
white graduation
DIN EN ISO 385

Catalogue Number	Volume ml	Division ml	Tolerance +/- ml
3150160	10	0.02	0.02
3150170	25	0.05	0.03
3150175	50	0.1	0.05

CERTIFICATES OF PERFORMANCE

9980101	Batch Certificate
9980102	Individual Certificate

HIRSCHMANN, GERMANY

HIRSCHMANN, GERMANY

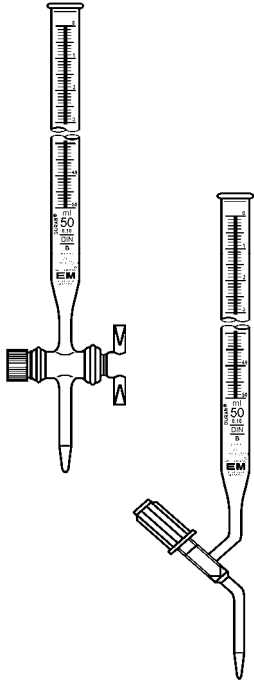

BURETTES, Class B, PTFE Key
Shellbach, blue graduation
 DIN EN ISO 385

Catalogue Number	Volume ml	Division ml	Tolerance +/- ml
311026029	10	0.02	0.03
311027029	25	0.05	0.045
311027529	50	0.1	0.075

HIRSCHMANN , GERMANY

Note : Available until stocks are exhausted.

BURETTES, Class B
Straight valve Stopcock with PTFE Spindle, short line

Shellbach, blue graduation
 DIN EN ISO 385

Catalogue Number	Volume ml	Division ml	Tolerance +/- ml
3110260	10	0.02	0.03
3110270	25	0.05	0.045
3110275	50	0.1	0.075

HIRSCHMANN , GERMANY

Note : Available until stocks are exhausted.

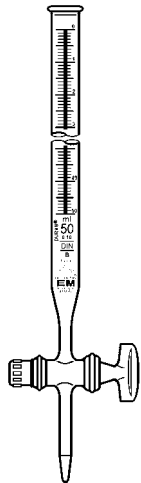

BURETTES, Class B, Glass Key

Shellbach, Short line,
 blue graduation
 DIN EN ISO 385

Catalogue Number	Volume ml	Division ml	Tolerance +/- ml
3110160	10	0.02	0.03
3110170	25	0.05	0.045
3110175	50	0.1	0.075

HIRSCHMANN , GERMANY

Note : Available until stocks are exhausted.

BURETTES, Class B, Glass Key
Amber Glass, Short line
Straight Stopcock with Glass Key

white graduation
 DIN EN ISO 385

Catalogue Number	Volume ml	Division ml	Tolerance +/- ml
3120160	10	0.02	0.03
3120170	25	0.05	0.045
3120175	50	0.1	0.075

HIRSCHMANN , GERMANY

DURAN, GERMANY



BURETTES, Class B
with straight stopcock
 ISO 385
 DURAN , GERMANY

Catalogue Number	Volume ml	Division ml	Tolerance +/- ml
2432839	100	0.2	0.15

HIRSCHMANN , GERMANY

BURETTES, Dafert Pattern
Three-Way Stopcock with Glass Key
Schellbach, straight form,
blue graduation, short line

Catalogue Number	Volume ml	Division ml	Tolerance +/- ml
3330170	25	0.1	0.045
3330175	50	0.1	0.075

HIRSCHMANN , GERMANY

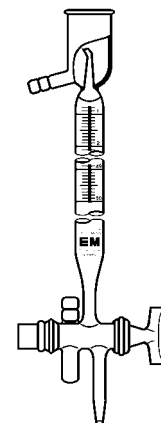

FAVORIT , MALAYSIA

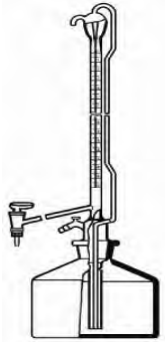

AUTOMATIC BURETTES, Class AS Glass Stopcock without Intermediate Stopcock	Catalogue Number	Volume ml	Division ml	Tolerance +/- ml
	BURETTE CW 2L RESERVOIR BOTTLE & BLOWBALL			
	P806510	10	0.02	0.02
	P806525	25	0.05	0.03
	P806550	50	0.1	0.05
	BURETTE ONLY			
	P806511	10	0.02	0.02
	P806526	25	0.05	0.03
	P806551	50	0.1	0.05

AUTOMATIC BURETTES, Class AS PTFE Stopcock without Intermediate Stopcock	Catalogue Number	Volume ml	Division ml	Tolerance +/- ml
	BURETTE CW 2L RESERVOIR BOTTLE & BLOWBALL			
	P806910	10	0.02	0.02
	P806925	25	0.05	0.03
	P806950	50	0.1	0.05
	BURETTE ONLY			
	P806911	10	0.02	0.02
	P806926	25	0.05	0.03
	P806951	50	0.1	0.05

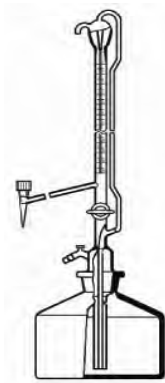

AUTOMATIC BURETTES, Class AS Glass Stopcock with Intermediate Stopcock	Catalogue Number	Volume ml	Division ml	Tolerance +/- ml
	BURETTE CW 2L RESERVOIR BOTTLE & BLOWBALL			
	P806610	10	0.02	0.02
	P806625	25	0.05	0.03
	P806650	50	0.1	0.05
	BURETTE ONLY			
	P806611	10	0.02	0.02
	P806626	25	0.05	0.03
	P806651	50	0.1	0.05

AUTOMATIC BURETTES, Class AS PTFE Stopcock with Intermediate Stopcock	Catalogue Number	Volume ml	Division ml	Tolerance +/- ml
	BURETTE CW 2L RESERVOIR BOTTLE & BLOWBALL			
	P806710	10	0.02	0.02
	P806725	25	0.05	0.03
	P806750	50	0.1	0.05
	BURETTE ONLY			
	P806711	10	0.02	0.02
	P806726	25	0.05	0.03
	P806751	50	0.1	0.05

DURAN , GERMANY

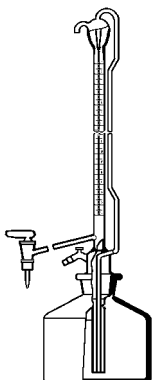

AUTOMATIC BURETTES, Class AS Glass Stopcock with Side Stopcock Schellbach, Pellet main graduations encircle the tube DIN 12700	Catalogue Number	Capacity ml	Division ml	Accuracy +/- ml
	BURETTE CW 2L RESERVOIR BOTTLE & BLOWBALL			
	24318275	10	0.02	0.02
	24318335	25	0.05	0.03
	24318365	50	0.1	0.05
	BURETTE ONLY			
	2431827	10	0.02	0.02
	2431833	25	0.05	0.03
	2431836	50	0.1	0.05

HIRSCHMANN , GERMANY

AUTOMATIC BURETTES, Class AS Conformity Certified, with Dated Batch Identification Lateral Stopcock w PTFE Spindle without Intermediate Stopcock Schellbach, Pellet blue graduation main point ring graduation DIN EN ISO 385	Catalogue Number	Capacity ml	Division ml	Accuracy +/- ml
		BURETTE CW 2L RESERVOIR BOTTLE & BLOWBALL		
	3440360	10	0.02	0.02
	3440370	25	0.05	0.03
	3440375	50	0.1	0.05
	BURETTE ONLY			
	344036060	10	0.02	0.02
	344037060	25	0.05	0.03
	344037560	50	0.1	0.05
HIRSCHMANN , GERMANY	CERTIFICATES OF PERFORMANCE			
	9980101	Batch Certificate		
	9980102	Individual Certificate		

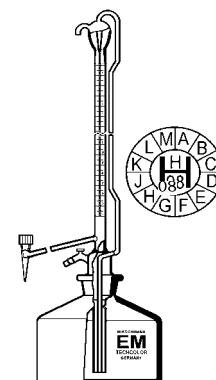

AUTOMATIC BURETTES, Class AS Conformity Certified, with Dated Batch Identification Lateral Glass Stopcock and Intermediate Stopcock Schellbach, Pellet blue graduation main point ring graduation DIN EN ISO 385	Catalogue Number	Capacity ml	Division ml	Accuracy +/- ml
		BURETTE CW 2L RESERVOIR BOTTLE & BLOWBALL		
	3540160	10	0.02	0.02
	3540170	25	0.05	0.03
	3540175	50	0.1	0.05
	BURETTE ONLY			
	354016060	10	0.02	0.02
	354017060	25	0.05	0.03
	354017560	50	0.1	0.05
HIRSCHMANN , GERMANY	CERTIFICATES OF PERFORMANCE			
	9980101	Batch Certificate		
	9980102	Individual Certificate		

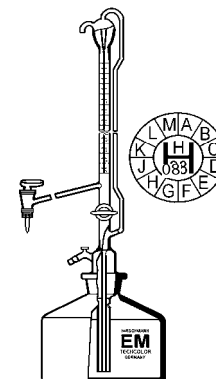

AUTOMATIC BURETTES, Class AS Conformity Certified, with Dated Batch Identification PTFE Spindle Stopcock and Intermediate Stopcock Schellbach, Pellet blue graduation main point ring graduation DIN EN ISO 385	Catalogue Number	Capacity ml	Division ml	Accuracy +/- ml
		BURETTE CW 2L RESERVOIR BOTTLE & BLOWBALL		
	3540360	10	0.02	0.02
	3540370	25	0.05	0.03
	3540375	50	0.1	0.05
	BURETTE ONLY			
	354036060	10	0.02	0.02
	354037060	25	0.05	0.03
	354037560	50	0.1	0.05
HIRSCHMANN , GERMANY	CERTIFICATES OF PERFORMANCE			
	9980101	Batch Certificate		
	9980102	Individual Certificate		

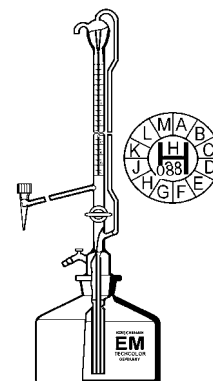

AUTOMATIC BURETTES, Class AS Amber Glass Conformity Certified, with Dated Batch Identification with Spindle of PTFE and Intermediate Stopcock Pellet, white graduation main point ring graduation DIN EN ISO 385	Catalogue Number	Volume ml	Division ml	Tolerance +/- ml
		BURETTE CW 2L RESERVOIR BOTTLE & BLOWBALL		
	3550360	10	0.02	0.02
	3550370	25	0.05	0.03
	3550375	50	0.1	0.05
	BURETTE ONLY			
	355036060	10	0.02	0.02
	355037060	25	0.05	0.03
	355037560	50	0.1	0.05
HIRSCHMANN , GERMANY	CERTIFICATES OF PERFORMANCE			
	9980101	Batch Certificate		
	9980102	Individual Certificate		

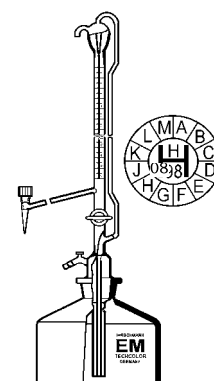

HIRSCHMANN, GERMANY

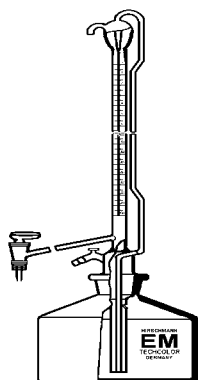
**AUTOMATIC BURETTES, Class B
Amber Glass**
Lateral Glass Stopcock

without Intermediate Stopcock
Pellet, short line, white graduation
DIN EN ISO 385

HIRSCHMANN, GERMANY

Catalogue Number	Capacity ml	Division ml	Accuracy +/- ml
BURETTE CW 2L RESERVOIR BOTTLE & BLOWBALL			
3420160	10	0.02	0.03
3420170	25	0.05	0.045
3420175	50	0.1	0.075
BURETTE ONLY			
342016060	10	0.02	0.03
342017060	25	0.05	0.045
342017560	50	0.1	0.075

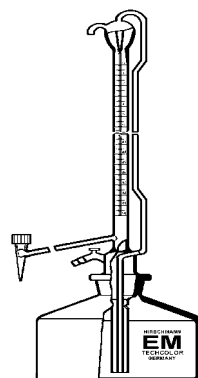
**AUTOMATIC BURETTES, Class B
Amber Glass**
Lateral Stopcock w PTFE Spindle

without Intermediate Stopcock
Pellet, short line, white graduation
DIN EN ISO 385

HIRSCHMANN, GERMANY

Catalogue Number	Volume ml	Division ml	Tolerance +/- ml
BURETTE CW 2L RESERVOIR BOTTLE & BLOWBALL			
3420360	10	0.02	0.03
3420370	25	0.05	0.045
3420375	50	0.1	0.075
BURETTE ONLY			
342036060	10	0.02	0.03
342037060	25	0.05	0.045
342037560	50	0.1	0.075

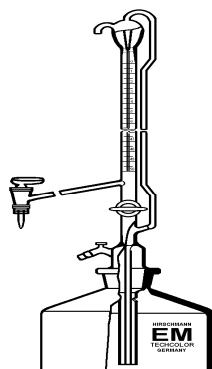
**AUTOMATIC BURETTES, Class B
Amber Glass**
**Lateral Glass Stopcock
with Intermediate Stopcock**

Pellet, short line, white graduation
DIN EN ISO 385

HIRSCHMANN, GERMANY

Catalogue Number	Volume ml	Division ml	Tolerance +/- ml
BURETTE CW 2L RESERVOIR BOTTLE & BLOWBALL			
3520160	10	0.02	0.03
3520170	25	0.05	0.045
3520175	50	0.1	0.075
BURETTE ONLY			
352016060	10	0.02	0.03
352017060	25	0.05	0.045
352017560	50	0.1	0.075

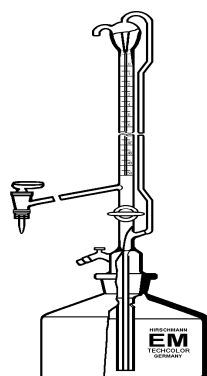
**AUTOMATIC BURETTES, Class B
Amber Glass**
**Lateral Stopcock w PTFE Spindle
and Intermediate Stopcock**

Pellet, short line, white graduation
DIN EN ISO 385

HIRSCHMANN, GERMANY

Catalogue Number	Volume ml	Division ml	Tolerance +/- ml
BURETTE CW 2L RESERVOIR BOTTLE & BLOWBALL			
3520360	10	0.02	0.03
3520370	25	0.05	0.045
3520375	50	0.1	0.075
BURETTE ONLY			
352036060	10	0.02	0.03
352037060	25	0.05	0.045
352037560	50	0.1	0.075

RESERVOIR BOTTLES
for Auto-Burettes

Catalogue Number	Capacity ml	Grd. Joint NS
Clear Glass		
SM10461	2000	29/32



BLOWBALL
for Auto-Burettes

Catalogue Number
DN4200005



HIRSCHMANN, GERMANY

AUTOMATIC BURETTES
Acc. To Dr. Schilling

fast flow burette
Schellbach, blue graduation
HIRSCHMANN , GERMANY

Catalogue Number	Volume ml	Division ml	Tolerance +/- ml
3600153	5	0.05	0.03
3600161	10	0.05	0.03
3600164	15	0.1	0.045
3600172	25	0.1	0.045
3600175	50	0.1	0.075

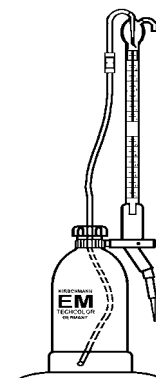

FAVORIT , MALAYSIA

AUTOMATIC BURETTES
Acc. To Dr. Schilling

fast flow burette
Schellbach, blue graduation
FAVORIT , MALAYSIA

Catalogue Number	Volume ml	Division ml	Tolerance +/- ml
P806410	10	0.05	0.03
P806415	15	0.1	0.045
P806425	25	0.1	0.045
P806450	50	0.1	0.075

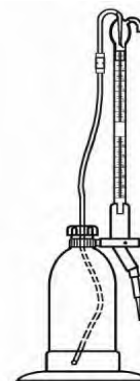

HIRSCHMANN, GERMANY

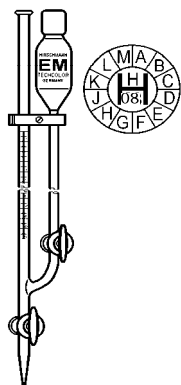

MICRO BURETTES, Class AS
Conformity Certified,
with Dated Batch Identification
Straight Stopcock, NS Glass Key
 with Stopcock at Filling-Tube
 Schellbach, Bang Pattern, Blue graduation
 main point ring graduation
 DIN EN ISO 385

Catalogue Number	Volume ml	Division ml	Tolerance +/- ml
3300140	2	0.01	0.01
3300152	5	0.02	0.01
3300160	10	0.02	0.02

HIRSCHMANN, GERMANY

CERTIFICATES OF PERFORMANCE

9980101	Batch Certificate
9980102	Individual Certificate

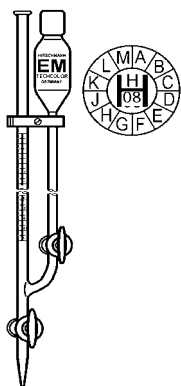

MICRO BURETTES, Class AS
Conformity Certified,
with Dated Batch Identification
Straight Stopcock with PTFE Key
 Stopcock at Filling-Tube
 Schellbach, Bang Pattern, Blue graduation
 main point ring graduation
 DIN EN ISO 385

Catalogue Number	Volume ml	Division ml	Tolerance +/- ml
3300240	2	0.01	0.01
3300252	5	0.02	0.01
3300260	10	0.02	0.02

HIRSCHMANN, GERMANY

CERTIFICATES OF PERFORMANCE

9980101	Batch Certificate
9980102	Individual Certificate

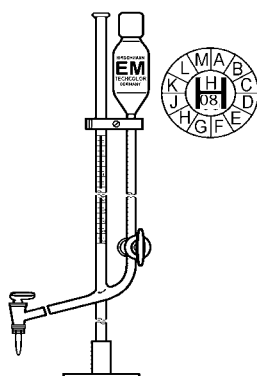

MICRO BURETTES, Class AS
Conformity Certified, ISO 9000
with Dated Batch Identification
Lateral Stopcock with NS Glass Key
 Stopcock at Filling-Tube w NS glass key
 with Support Base
 Schellbach, Bang Pattern, Blue graduation
 main point ring graduation
 DIN EN ISO 385

Catalogue Number	Volume ml	Division ml	Tolerance +/- ml
3310140	2	0.01	0.01
3310152	5	0.02	0.01
3310160	10	0.02	0.02

HIRSCHMANN, GERMANY

CERTIFICATES OF PERFORMANCE

9980101	Batch Certificate
9980102	Individual Certificate

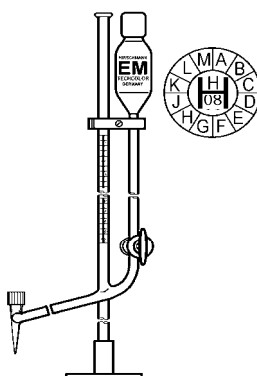

MICRO BURETTES, Class AS
Conformity Certified, ISO 9000
with Dated Batch Identification
Lateral Stopcock with PTFE Spindle
 Stopcock at Filling-Tube w PTFE key
 with Support Base
 Schellbach, Bang Pattern, Blue graduation
 main point ring graduation
 DIN EN ISO 385

Catalogue Number	Volume ml	Division ml	Tolerance +/- ml
3310340	2	0.01	0.01
3310352	5	0.02	0.01
3310360	10	0.02	0.02

HIRSCHMANN, GERMANY

CERTIFICATES OF PERFORMANCE

9980101	Batch Certificate
9980102	Individual Certificate

HIRSCHMANN, GERMANY

COUNTING CHAMBERS Double Net Ruling	Catalogue	System	Depth
	Number		mm
Including 2 Cover Glasses for Haemocytometer CE acc. IVD 98/79 EC	8100101	Burker	0.1
	8100103	Neubauer	0.1
	8100104	Neubauer - Improved	0.1
	8100105	Thoma	0.1
	8100106	Thoma - New	0.1
	8100110	Fuchs - Rosenthal	0.2
HIRSCHMANN , GERMANY	8100111	Nageotte	0.5

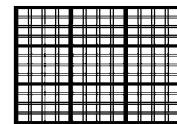

Bürker

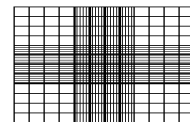

Neubauer

COUNTING CHAMBERS Double Net Ruling Bright-lined	Catalogue	System	Depth
	Number		mm
Including 2 Cover Glasses for Haemocytometer CE acc. IVD 98/79 EC	8100201	Burker	0.1
	8100203	Neubauer	0.1
	8100204	Neubauer - Improved	0.1
	8100205	Thoma	0.1
	8100206	Thoma - New	0.1
	8100210	Fuchs - Rosenthal	0.2
HIRSCHMANN , GERMANY	8100211	Nageotte	0.5

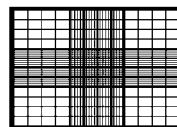

Neubauer - improved

COUNTING CHAMBERS Double Net Ruling with Clamps Bright-lined	Catalogue	System	Depth
	Number		mm
Including 2 Cover Glasses for Haemocytometer CE acc. IVD 98/79 EC	8110101	Burker	0.1
	8110103	Neubauer	0.1
	8110104	Neubauer - Improved	0.1
	8110105	Thoma	0.1
	8110106	Thoma - New	0.1
	8110110	Fuchs - Rosenthal	0.2
HIRSCHMANN , GERMANY	8110111	Nageotte	0.5

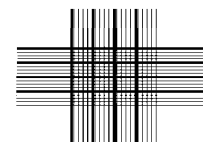

Thoma

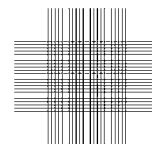

Thoma - neu

COUNTING CHAMBERS Double Net Ruling with Clamps Bright-lined	Catalogue	System	Depth
	Number		mm
Including 2 Cover Glasses for Haemocytometer CE acc. IVD 98/79 EC	8110201	Burker	0.1
	8110203	Neubauer	0.1
	8110204	Neubauer - Improved	0.1
	8110205	Thoma	0.1
	8110206	Thoma - New	0.1
	8110210	Fuchs - Rosenthal	0.2
HIRSCHMANN , GERMANY	8110211	Nageotte	0.5

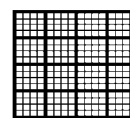

Fuchs - Rosenthal

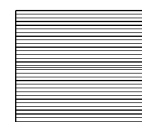

Nageotte

DURAN, GERMANY

MICROSCOPE SLIDES 26 X 76MM (D X L)	Catalogue Number	
Glass Thickness 1.0 ± 0.05mm	2355011	Cut Edges
ISO 8037/I	2355012	Cut Edges, Frosted End
	2355013	Ground Edges 45°
DURAN , GERMANY	2355014	Ground Edges 45°, Frosted End

MICROSCOPE SLIDES 26 X 76MM (D X L)	Catalogue Number	Colour
Colored, Ground Edges 90°	2355022	Blue
Glass Thickness 1.0 ± 0.05mm	2355021	White
ISO 8037/I	2355023	Yellow
DURAN , GERMANY	2355024	PRINT, White, with Rounded Corners

MICROSCOPE SLIDES 26 X 76MM (D X L)	Catalogue Number	
Coated, White Colour	2355025	Adhesive with Standard Coating
Ground Edges 90°	2355026	Adhesive with Top Quality Coating
Glass Thickness 1.0 ± 0.05mm		
ISO 8037/I		
DURAN , GERMANY		

COVER SLIPS for Microscopy	Catalogue Number	Size mm
Glass Thickness 1.0 ± 0.05mm	2355031	18 x 18
	2355032	22 x 22
	2355033	24 x 40
	2355034	24 x 50
DURAN , GERMANY	2355036	24 x 60

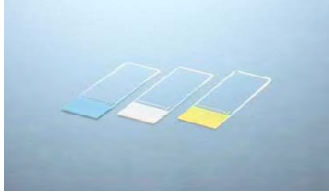

HIRSCHMANN, GERMANY

COVER GLASS for Microscopy	Catalogue Number	Size mm
Thickness 0.13 - 0.17 mm	8000101	15 x 15
DIN 58884	8000102	18 x 18
CE acc. IVD 98/79 EC	8000103	20 x 20
	8000104	22 x 22
HIRSCHMANN , GERMANY	8000105	24 x 24
	8000109	22 x 32
	8000110	22 x 40
	8000111	22 x 50
	8000112	22 x 60
	8000115	24 x 32
	8000116	24 x 40
	8000119	24 x 50
	8000120	24 x 60

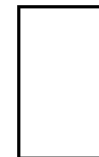

FAVORIT, MALAYSIA

COVER GLASS for Microscopy	Catalogue Number	Size mm
	P821104	22 x 22
	P821115	24 x 32
	P821116	24 x 40
	P821119	24 x 50
FAVORIT , MALAYSIA	P821120	24 x 60

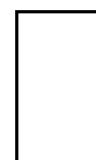

DURAN, GERMANY

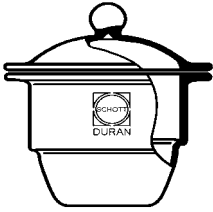

DESICCATORS with Knobbed Lid with Flat Flange without Junction DIN 12491	Catalogue Number	DN
DURAN , GERMANY	2478146	100
	2478157	150
	2478161	200
	2478166	250
	2478169	300

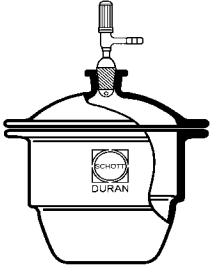

VACUUM DESICCATORS with Outlet in Lid with Stopcock with Flat Flange and NOVUS NS Junction DIN 12491	Catalogue Number	DN	Tubulature NS
DURAN , GERMANY	2478246	100	24/29
	2478257	150	24/29
	2478261	200	24/29
	2478266	250	24/29
	2478269	300	24/29



DESICCATORS BASES with Flat Flange, no outlet for all types of lids DIN 12491	Catalogue Number	DN
DURAN , GERMANY	2477046	100
	2477057	150
	2477061	200
	2477066	250
	2477069	300



DESICCATOR LIDS with KNOB fits all bases	Catalogue Number	DN
DURAN , GERMANY	Clear	
	2441046	100
	2441057	150
	2441061	200
	2441066	250
	2441069	300



DESICCATOR LIDS with OUTLET for Normal NS Stopcock NOVUS Type DIN 12491 with NS24/29	Catalogue Number	DN
DURAN , GERMANY	Clear	
	2442046	100
	2442057	150
	2442061	200
	2442066	250
	2442069	300

DURAN, GERMANY

METAL DESICCATOR PLATES	Catalogue Number	DN
	2908046	100
2908057	150	
2908061	200	
2908066	250	
2908069	300	

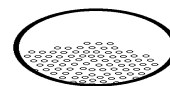

PORCELAIN DESICCATOR PLATES DIN 12911	Catalogue Number	DN
	2972546	100
2972557	150	
2972561	200	
2972566	250	
2972569	300	

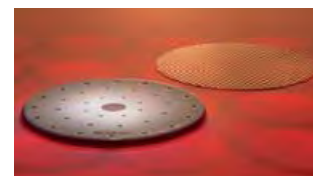

STOPCOCK with PTFE Spindle for NOVUS Tubulated Lid with NS24/29 Cone DURAN , GERMANY	Catalogue Number	Length mm
	2479904	124



STOPCOCK with PTFE Spindle for NOVUS Side Outlet with NS24/29 Cone DURAN , GERMANY	Catalogue Number	Length mm
	2479803	108

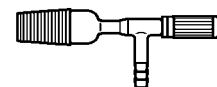

STOPCOCK with PTFE Spindle for MOBILEX Screw thread Outlet DURAN , GERMANY	Catalogue Number	Length mm
	2479703	160

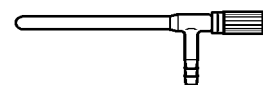

PETRI DISHES, Duroplan Borosilicate Glass Bottom dish and lid inside and outside microscopic flat, free of bubbles and other imperfections DURAN , GERMANY	Catalogue Number	O. D. X Height mm
	2175541	60 x 20
2175543	80 x 20	
2175546	100 x 15	
2175548	100 x 20	
2175551	120 x 20	
2175553	150 x 27	



PETRI DISHES, Steriplan Soda-Lime Glass DURAN , GERMANY	Catalogue Number	O. D. X Height mm
	2375539	40 x 12
2375540	60 x 15	
2375542	80 x 15	
1184071	90 x 15	
2375545	100 x 10	
2375546	100 x 15	
2375548	100 x 20	
2375551	120 x 20	
2375552	150 x 25	
2375556	180 x 30	
2375559	200 x 30	
2375561	200 x 45	



BOECKEL , Germany



PETRI DISHES, Petriq Soda-Lime Glass

Catalogue Number	O. D. X Height mm
PET4006015	60 x 15
PET4007015	70 x 15
PET4008015	80 x 15
PET4010010	100 x 10
PET4012020	120 x 20
PET4020030	200 x 30

Note : Available until stocks are exhausted.

DURAN, GERMANY



WATCH GLASS DISHES

Soda-Lime Glass
with fused edges
DIN 12341

DURAN , GERMANY

DURAN borosilicate glass
WATCH GLASS DISHES
also available

Catalogue Number	O. D. mm
2332124	40
2332132	50
2332134	60
2332138	70
2332141	80
2332143	90
2332146	100
2332151	120
2332152	125
2332157	150
2332161	200
2332166	250



EVAPORATING DISHES

with Spout
DIN 12336

DURAN , GERMANY

1 : without print
2 : without labelling field

Catalogue Number	Capacity ml	Rim O.D. mm	Height mm
2130132 ¹	15	50	25
2130134 ¹	45	60	30
2130138 ²	60	70	35
2130141 ²	90	80	45
2130144	170	95	55
2130149	320	115	65
2130154	600	140	80
2130159	1500	190	100
2130163	2500	230	130



CRYSTALLIZING DISHES

with Spout
DIN 12338

DURAN , GERMANY

1 : without print

Catalogue Number	Capacity ml	Rim O.D. mm	Height mm
2131124 ¹	20	40	25
2131132 ¹	40	50	30
2131134 ¹	60	60	35
2131138	100	70	40
2131141	150	80	45
2131144	300	95	55
2131149	500	115	65
2131154	900	140	75
2131159	2000	190	90
2131163	3500	230	100

CRYSTALLIZING DISHES

without Spout
DIN 12337

DURAN , GERMANY

1 : without print

Catalogue Number	Capacity ml	Rim O.D. mm	Height mm
2131324 ¹	20	40	25
2131332 ¹	40	50	30
2131334 ¹	60	60	35
2131338	100	70	40
2131341	150	80	45
2131344	300	95	55
2131349	500	115	65
2131354	900	140	75
2131359	2000	190	90
2131363	3500	230	100

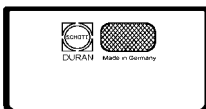

DURAN, GERMANY

ERLENMEYER FLASKS Narrow Neck	Catalogue Number	Capacity ml
with graduation	2121614	25
ISO 1773	2121617	50
with Retrace Code	2121624	100
	2199027	150
	2121632 ¹	200
DURAN , GERMANY	2121636	250
	2121639 ¹	300
	2121644	500
	2121654	1000
	2121663	2000
1 : non-ISO size	2121668	3000
	2121673	5000

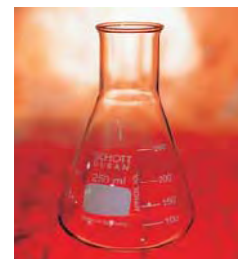

ERLENMEYER FLASKS Wide Neck	Catalogue Number	Capacity ml
with graduation	2122614 ¹	25
DIN ISO 24450	2122617	50
with Retrace Code	2122624	100
	2122632	200
DURAN , GERMANY	2122636	250
	2122639	300
	2122644	500
1 : non-DIN size	2122654	1000
	2122663 ¹	2000



CONICAL FLASKS Wide Neck	Catalogue Number	Capacity ml
Non-DIN Size	2122768	3000
without graduation	2122773	5000
DURAN , GERMANY	2122786	10000



ERLENMEYER FLASKS with Screw-Cap	Catalogue Number	Capacity ml	DIN Thread
with DIN thread and graduation	21803175	50	GL 25
	21803245	100	GL 25
FAVORIT, MALAYSIA	21803325	200	GL 32
Important :	21803365	250	GL 32
Do not autoclave flasks	21803445	500	GL 32
with a tightly screwed cap.	21803545	1000	GL 32
	21803635	2000	GL 45
	21803685	3000	GL 45

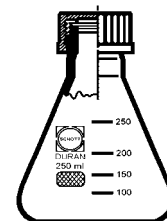

DISTILLING FLASKS	Catalogue Number	Capacity ml
DURAN , GERMANY	2124324	100
	2124336	250
Note : Available until stocks	2124344	500
are exhausted.	2124354	1000



DISTILLING FLASKS Engler	Catalogue Number	Capacity ml
	2165324	100
	2165328	125
DURAN , GERMANY	2165329	150



DISTILLING FLASKS Engler	Catalogue Number	Capacity ml	Socket Size
with Standard Ground Joint	2465328	125	19/26

DURAN , GERMANY



DURAN, GERMANY

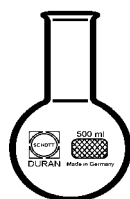

ROUND BOTTOM FLASKS

Narrow Neck

with beaded rim
ISO 1773

DURAN, GERMANY

Catalogue Number	Capacity ml
2172117	50
2172124	100
2172136	250
2172144	500
2172154	1000
2172164 ¹	2000
2172168 ¹	3000
2172171	4000
2172173	5000
2172177 ¹	6000
2172186	10000
2172187 ^{1,2}	12000
2172191 ²	20000

1 : non-DIN size

2 : non-ISO size



ROUND BOTTOM FLASKS

Wide Neck

with beaded rim
DIN ISO 24450

DURAN, GERMANY

Catalogue Number	Capacity ml
2174117	50
2174124	100
2174136	250
2174144	500
2174154	1000
2174164	2000
2174168	3000
2174171 ¹	4000
2174173	5000
2174177	6000
2174186 ¹	10000
2174191 ¹	20000

1 : non-DIN size

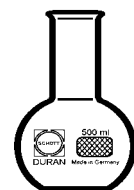

FLAT BOTTOM FLASKS

Narrow Neck

with beaded rim
DIN ISO 1773

DURAN, GERMANY

Catalogue Number	Capacity ml
2171117	50
2171124	100
2171136	250
2171144	500
2171154	1000
2171164 ¹	2000
2171168	3000
2171171	4000
2171173	5000
2171176 ²	6000
2171186 ²	10000

1 : non-ISO size

2 : Flasks have a reinforced rim



FLAT BOTTOM FLASKS

Wide Neck

with beaded rim
DIN ISO 24450

DURAN, GERMANY

Catalogue Number	Capacity ml
2173117	50
2173124	100
2173136	250
2173144	500
2173154	1000
2173163 ^{1,2}	2000
2173164	2000

1 : Flasks have a reinforced rim

2 : non-DIN size

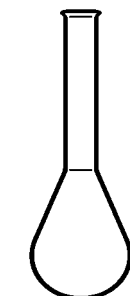

KJELDAHL FLASKS

DIN 12360

DURAN, GERMANY

Catalogue Number	Capacity ml
2123151	750
2123154	1000

KJELDAHL FLASKS

DIN 12360

FAVORIT, MALAYSIA

Catalogue Number	Capacity ml
P812015	30
P812017	50
P812024	100
P812036	250
P812038	300
P812044	500

DURAN, GERMANY

FILTERING FLASKS Glass Hose Connection	Catalogue Number	Capacity ml
Erlenmeyer Shape ISO 6556	2120124	100
	2120136	250
	2120144	500
DURAN , GERMANY	2120154	1000
	2120163	2000

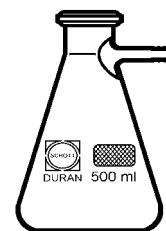

FILTERING FLASKS Glass Hose Connection	Catalogue Number	Capacity ml
Bottle Shape	2119168	3000
	2119173	5000
	2119186	10000
DURAN , GERMANY	2119188	15000
	2119191	20000



FILTERING FLASKS Plastic Hose Connection	Catalogue Number	Capacity ml
Erlenmeyer Shape DIN 12476 , ISO 6556	21204245	100
	21204365	250
	21204445	500
DURAN , GERMANY	21204545	1000
	21204635	2000

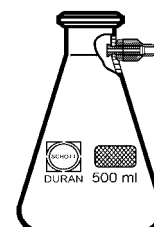

FILTERING FLASKS Plastic Hose Connection	Catalogue Number	Capacity ml
Bottle Shape	21194685	3000
	21194735	5000
	21194865	10000
DURAN , GERMANY	21194885	15000
	21194915	20000



PLASTIC HOSE CONNECTION ASSEMBLY SET	Catalogue Number
SCHOTT , GERMANY	2925854

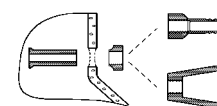

VOLUMETRIC FLASKS Class A with PE Stopper	Catalogue Number	Capacity ml	Stopper Size	Accuracy +/- ml
DURAN	2167807	5	7/16	0.025
	2167808	10	10/19	0.025
	2167812	20	10/19	0.04
	2167814	25	10/19	0.04
	2167817	50	12/21	0.06
	2167824	100	12/21	0.1
	2167832	200	14/23	0.15
	2167836	250	14/23	0.15
	2167844	500	19/26	0.25
	2167854	1000	24/29	0.4
	2167863	2000	29/32	0.6
	2167873	5000	34/35	1.2

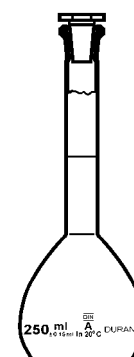

FAVORIT , MALAYSIA

VOLUMETRIC FLASKS Class A with PE Stopper Blue Graduation	Catalogue Number	Capacity ml	Stopper Size	Accuracy +/- ml
FAVORIT	P809007	5	7/16	0.025
	P809008	10	10/19	0.025
	P809012	20	10/19	0.04
	P809014	25	10/19	0.04
	P809017	50	12/21	0.06
	P809024	100	12/21	0.1
	P809032	200	14/23	0.15
	P809036	250	14/23	0.15
	P809044	500	19/26	0.25
	P809054	1000	24/29	0.4
	P809063	2000	29/32	0.6

VOLUMETRIC FLASKS Class A with Hollow Glass Stopper Blue Graduation	Catalogue Number	Capacity ml	Stopper Size	Accuracy +/- ml
FAVORIT	P809007G	5	7/16	0.025
	P809008G	10	10/19	0.025
	P809012G	20	10/19	0.04
	P809014G	25	10/19	0.04
	P809017G	50	12/21	0.06
	P809024G	100	12/21	0.1
	P809032G	200	14/23	0.15
	P809036G	250	14/23	0.15
	P809044G	500	19/26	0.25
	P809054G	1000	24/29	0.4
	P809063G	2000	29/32	0.6

VOLUMETRIC FLASKS Amber Glass Class A with PE Stopper Blue Graduation	Catalogue Number	Capacity ml	Stopper Size	Accuracy +/- ml
FAVORIT	P809007AP	5	7/16	0.025
	P809008AP	10	10/19	0.025
	P809012AP	20	10/19	0.04
	P809014AP	25	10/19	0.04
	P809017AP	50	12/21	0.06
	P809024AP	100	12/21	0.1
	P809032AP	200	14/23	0.15
	P809036AP	250	14/23	0.15
	P809044AP	500	19/26	0.25
	P809054AP	1000	24/29	0.4
	P809063AP	2000	29/32	0.6

VOLUMETRIC FLASKS Amber Glass Class A with Hollow Amber Glass Stopper Blue Graduation	Catalogue Number	Capacity ml	Stopper Size	Accuracy +/- ml
FAVORIT	P809007AG	5	7/16	0.025
	P809008AG	10	10/19	0.025
	P809012AG	20	10/19	0.04
	P809014AG	25	10/19	0.04
	P809017AG	50	12/21	0.06
	P809024AG	100	12/21	0.1
	P809032AG	200	14/23	0.15
	P809036AG	250	14/23	0.15
	P809044AG	500	19/26	0.25
	P809054AG	1000	24/29	0.4
	P809063AG	2000	29/32	0.6

HIRSCHMANN, GERMANY

VOLUMETRIC FLASKS, Class A Conformity Certified, with Dated Batch Identification with Poly Stopper Blue Graduation DIN EN ISO 1042	Catalogue	Capacity	Ground	Tolerance
	Number	ml	Joint NS	+/- ml
	2820153	5	10/19	0.04
	2820161	10	10/19	0.04
	2820165	20	10/19	0.04
	2820170	25	10/19	0.04
	2820175	50	12/21	0.06
	2820180	100	12/21	0.1
	2820185	200	14/23	0.15
	2820186	250	14/23	0.15
	2820190	500	19/26	0.25
	2820193	1000	24/29	0.4
	2820194	2000	29/32	0.6
	2820197	5000	34/35	1.2
	2820198	10000	45/40	2
CERTIFICATES OF PERFORMANCE				
	9980101	Batch Certificate		
	9980102	Individual Certificate		

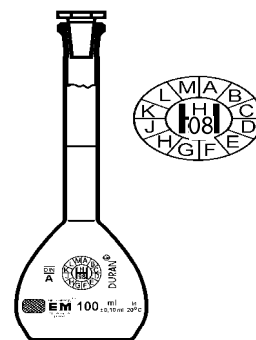

VOLUMETRIC FLASKS, Class A Conformity Certified with Dated Batch Identification with Hollow Glass Stopper Blue Graduation DIN EN ISO 1042	Catalogue	Capacity	Ground	Tolerance
	Number	ml	Joint NS	+/- ml
	2820253	5	10/19	0.04
	2820261	10	10/19	0.04
	2820265	20	10/19	0.04
	2820270	25	10/19	0.04
	2820275	50	12/21	0.06
	2820280	100	12/21	0.1
	2820285	200	14/23	0.15
	2820286	250	14/23	0.15
	2820290	500	19/26	0.25
	2820293	1000	24/29	0.4
	2820294	2000	29/32	0.6
	2820297	5000	34/35	1.2
	2820298	10000	45/40	2
CERTIFICATES OF PERFORMANCE				
	9980101	Batch Certificate		
	9980102	Individual Certificate		



VOLUMETRIC FLASKS, Class A Amber Glass Conformity Certified, ISO 9000 with Dated Batch Identification with Poly Stopper Blue Graduation DIN EN ISO 1042	Catalogue	Capacity	Ground	Tolerance
	Number	ml	Joint NS	+/- ml
	2640153	5	10/19	0.04
	2640161	10	10/19	0.04
	2640165	20	10/19	0.04
	2640170	25	10/19	0.04
	2640175	50	12/21	0.06
	2640180	100	12/21	0.1
	2640185	200	14/23	0.15
	2640186	250	14/23	0.15
	2640190	500	19/26	0.25
	2640193	1000	24/29	0.4
	2640194	2000	29/32	0.6
CERTIFICATES OF PERFORMANCE				
	9980101	Batch Certificate		
	9980102	Individual Certificate		

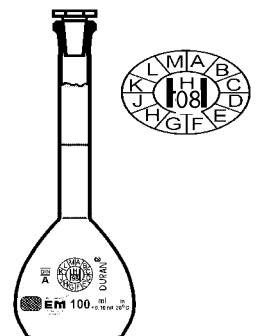

VOLUMETRIC FLASKS, Class A Amber Glass Conformity Certified, ISO 9000 with Dated Batch Identification with Hollow Amber Glass Stopper Blue Graduation DIN EN ISO 1042	Catalogue	Capacity	Ground	Tolerance
	Number	ml	Joint NS	+/- ml
	2640253	5	10/19	0.04
	2640261	10	10/19	0.04
	2640265	20	10/19	0.04
	2640270	25	10/19	0.04
	2640275	50	12/21	0.06
	2640280	100	12/21	0.1
	2640285	200	14/23	0.15
	2640286	250	14/23	0.15
	2640290	500	19/26	0.25
	2640293	1000	24/29	0.4
	2640294	2000	29/32	0.6
CERTIFICATES OF PERFORMANCE				
	9980101	Batch Certificate		
	9980102	Individual Certificate		



DURAN, GERMANY

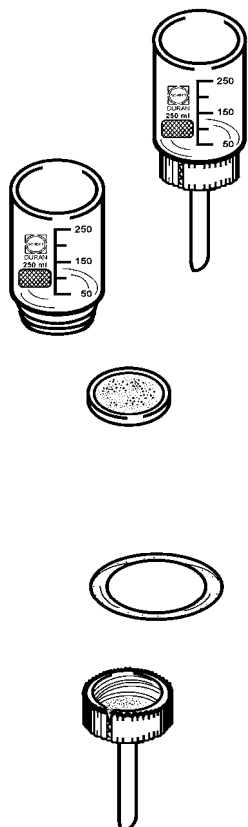

FILTER HEAD with PP Funnel and 2 FKM Seals	Catalogue Number	Capacity ml	For Disc Dia. mm
DURAN , GERMANY	2472024	30	24
	2472050	250	50
	2472090	1000	90
<i>NOTE : Filter discs with glass rim must be ordered separately.</i>			
FILTER HEAD with Screwthread	Catalogue Number	Capacity ml	Thread Size mm
DURAN , GERMANY	2472124	30	28
	2472150	250	54
	2472190	1000	95
FILTER DISC with Glass Rim Patented	Catalogue Number	Disc Dia. mm	Porosity Por.
DURAN , GERMANY	2520241 / 2 / 3	24	1 - 3
	2520244	24	4
	2520501 / 2 / 3	50	1 - 3
	2520504	50	4
	2520901 / 2 / 3	90	1 - 3
	2520904	90	4
FKM SEALS	Catalogue Number	Suitable Disc Dia. mm	
DURAN , GERMANY	2922024	24	
	2922050	50	
	2922090	90	
PP FUNNEL for Filter Head	Catalogue Number	Thread Size mm	Stem O.D. mm
DURAN , GERMANY	2922124	28	10
	2922150	54	12
	2922190	95	18

FILTER CRUCIBLES	Catalogue Number	Capacity ml	Porosity Por.	Suitable Rubber Sleeve Cat.No.	Suitable Filter Adapter Cat.No.
DURAN , GERMANY	258510X	¹ 8	2-3	2920114	2431616
	2585104	¹ 8	4	2920114	2431616
	258511X	¹ 15	1-3	2920121	2431622
	2585114	¹ 15	4	2920121	2431622
	258512X	¹ 30	1-3	2920126	2431626
	2585124	¹ 30	4	2920126	2431626
	2585125	¹ 30	5	2920126	2431626
	258513X	¹ 50	1-3	2920131	2431632
	2585134	¹ 50	4	2920131	2431632
	2585135	¹ 50	5	2920131	2431632

NOTE :
¹ The required porosity should be inserted in place of X in the catalogue number.

FAVORIT , MALAYSIA

FILTER CRUCIBLES	Catalogue Number	Capacity ml	Porosity Por.
FAVORIT , MALAYSIA	P81651X	¹ 15	1-3
	P816514	15	4
	P81652X	¹ 30	1-3
	P816524	30	4
	P816525	30	5
	P81653X	¹ 50	1-3
NOTE : ¹ The required porosity should be inserted in place of X in the catalogue number.	P816534	50	4
	P816535	50	5

DURAN, GERMANY

GUKO CONICAL GASKETS

Made of EPDM

DURAN, GERMANY

Catalogue Number	Top O.D. mm	Btm O.D. mm	Suitable Filter Flask Capacity	Suitable Filter Adapter Cat.No.
2920212	22	12	-	-
2920217	29	16	100ml	2431616
2920223	36	22	100ml	2431616
2920227	44	27	250/500ml	2431622
2920232	53	33	1000ml	2431626
2920236	63	43	1000ml	2431632
2920239	73	52	2L/3L	2431632
2920243	84	61	5L/20L	2431632
2920200	(Complete Set --- 8 Guko Cones Sizes 22 to 84)			



for Filter Crucibles

made of EPDM

Sterilizable up to 180 °C.

DURAN, GERMANY

Catalogue Number	O.D. mm	Filter Crucible Cat.No.	Filter Adapter Cat.No.
2920114	26	258510X	2431616
2920121	33	258511X	2431622
2920126	41	258512X	2431626
2920131	49	258513X	2431632



FILTER FUNNELS, Sintered

DURAN, GERMANY

Catalogue Number	Capacity ml	Porosity Por.	Disc Dia. mm
258520X ¹	50	1-3	35
2585204	50	4	35
2585205	50	5	35
258521X ¹	75	1-3	45
2585214	75	4	45
2585215	75	5	45
258522X ¹	125	1-3	60
2585224	125	4	60
2585225	125	5	60
258523X ¹	500	1-3	95
2585234	500	4	95
2585235	500	5	95
258524X ¹	1000	1-3	120
2585244	1000	4	120
2585245	1000	5	120
258526X	4000	1	175
258526X	4000	2-3	175
2585264	4000	4	175

NOTE :

- 1 The required porosity should be inserted in place of X in the catalogue number.

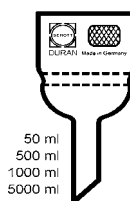

FILTER FUNNELS

Conical Shape

DURAN, GERMANY

Catalogue Number	Capacity ml	Porosity Por.	Disc Dia. mm
2585403	25	3	25
2585404	25	4	25

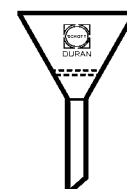

BUECHNER FUNNELS

support for membrane and paper filter

DURAN, GERMANY

Catalogue Number	Capacity ml	Disc Dia. mm	Matching Filter Paper Dia. mm
2134122	70	48	45
2134128	125	60	55
2134134	220	73	70
2134144	500	95	90
2134154	1000	120	110

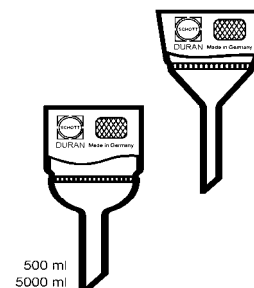

DURAN, GERMANY



FILTER FUNNEL ADAPTERS

DURAN, GERMANY

Catalogue Number	Top I.D. mm	Length mm	Suitable Rubber Sleeve Cat.No.
2431616	27	110	2920114
2431622	34	110	2920121
2431626	41	125	2920126
2431632	50	132	2920131

DURAN FUNNELS, Short Stem

Borosilicate Glass

DURAN, GERMANY

Catalogue Number	Top I.D. mm	Stem Length mm	Matching Filter Paper Dia. mm
2135123	35	35	45-55
2135128 ¹	45	45	55-70
2135133	55	55	70-90
2135138 ¹	70	70	110-125
2135141	80	80	125-150
2135146	100	100	150-185
2135151 ¹	120	120	185-240
2135157	150	150	240-270
2135159 ¹	180	150	270-320
2135161 ¹	200	175	320-385
2135166 ¹	250	175	385-400
2135169 ¹	300	175	500

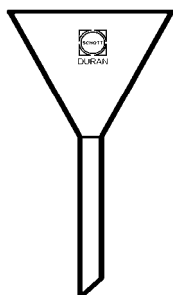

FUNNELS, Short Stem

Soda-Lime Glass

DURAN, GERMANY

2335123	35	35	45-55
2335128 ¹	45	45	55-70
2335133	55	55	70-90
2335138 ¹	70	70	110-125
2335141	80	80	125-150
2335146	100	100	150-185

1 : non-DIN ISO size

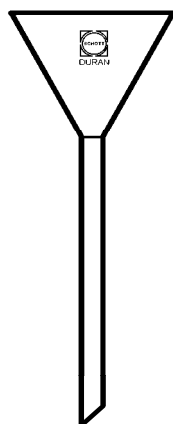

FUNNELS, Long Stem

Borosilicate Glass

DURAN, GERMANY

Catalogue Number	Top I.D. mm	Stem Length mm	Matching Filter Paper Dia. mm
2135333	55	150	70-90
2135338 ¹	70	150	110-125
2135341 ¹	80	150	125-150

FUNNELS, Long Stem

Soda-Lime Glass

DURAN, GERMANY

2335333	55	150	70-90
2335338 ¹	70	150	110-125
2335341 ¹	80	150	125-150
2335346	100	150	150-185

1 : non-DIN ISO size

FAVORIT, MALAYSIA

FUNNELS, Short Stem

Borosilicate Glass

FAVORIT, MALAYSIA

Catalogue Number	Top I.D. mm	Stem Length mm	Matching Filter Paper Dia. mm
P816123	35	35	45-55
P816125	40	40	45-55
P816128	45	45	55-70
P816133	55	55	70-90
P816135	60	60	70-90
P816138	70	70	110-125
P816141	80	80	125-150
P816146	100	100	150-185

DURAN, GERMANY

	Catalogue Number	Top I.D. mm	Stem Length mm
DURAN POWDER FUNNELS with Short, Wide Stem Borosilicate Glass DURAN , GERMANY	2135433	55	30
	2135438	70	30
	2135441	80	30
	2135446	100	30
	2135451	120	30
	2135455	160	30
	2135461	200	30
POWDER FUNNELS with Short, Wide Stem Soda-Lime Glass	2335433	55	30
	2335438	70	30
	2335441	80	30
	2335446	100	30

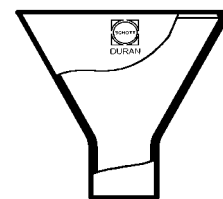

	Catalogue Number	Rim I.D. mm	Stem Length mm	Matching Filter Paper Dia. mm
FUNNELS, Ribbed DURAN , GERMANY	2135238	70	70	110-125
	2135241	80	80	125-150
	2135246	100	100	150-185
	2135257	150	150	240-270
	2135261	200	200	320-385

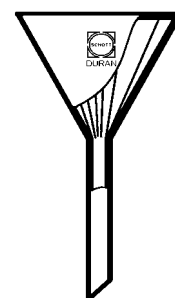

FAVORIT , MALAYSIA



47MM FILTRATION ASSY.
with 40/35 Connection
with Fritted Glass
Support

Catalogue Number	Description
P811613	47 mm Filtration Assembly with 300mL Funnel, 1L Flask

Components

P811613-01	(1) Glass Funnel, 47 mm, 300 mL
P811613-02	(2) Aluminium Clamp, 47 mm
P811613-03	(3) Fritted Support Base, 47 mm, 40/35
P811613-04	(4) Filter Flask, 1000 mL, with 40/35 Inner Joint



47MM FILTRATION ASSY.
with No. 8 Stopper
Connections
with Fritted Glass
Support

Catalogue Number	Description
P811347	47 mm Filtration Assembly with Fritted Support

(without Filtering Flask)

Components

P811347-01	(1) Glass Funnel, 47 mm, 300 mL
P811347-02	(2) Aluminium Clamp, 47 mm
P811347-03	(3) Fritted Support Base, 47 mm
P811347-04	(4) Silicone Stopper, No. 8

DURAN , GERMANY



FILTERING APPARATUS
complete set

DURAN , GERMANY

Catalogue Number	Description
2571043	comprises the following items :

Components

21204445	500ml Filtering Flask with KECK Ass. Set
2920227	Rubber Gasket 44mm Top, 27mm Bottom
2431626	Filter Funnel 41mm
2920126	41mm Rubber Sleeve
2585123	Filter Crucible 30ml, Porosity 3
2585124	Filter Crucible 30ml, Porosity 4

HOLLOW GLASS STOPPERS HEXAGONAL HEAD	Catalogue	
	Number	Cone Size
GERMANY	JSB07	7/16
	JSB10	10/19
	JSB12	12/21
	JSB14	14/23
	JSB19	19/26
	JSB24	24/29
	JSB29	29/32
	JSB34	34/35

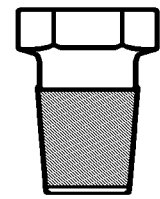

HOLLOW GLASS STOPPERS, Amber	Catalogue	
	Number	Cone Size
GERMANY	JSB07A	7/16
	JSB10A	10/19
	JSB12A	12/21
	JSB14A	14/23
	JSB19A	19/26
	JSB24A	24/29
	JSB29A	29/32
	JSB34A	34/35

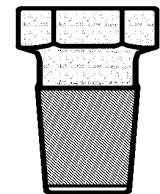

FAVORIT , MALAYSIA

GLASS STOPPERS ELONGATED HEAD	Catalogue	
	Number	Cone Size
FAVORIT , MALAYSIA	PGS10	10/19
	PGS12	12/21
	PGS14	14/23
	PGS19	19/26
	PGS24	24/29
	PGS29	29/32
	PGS34	34/35

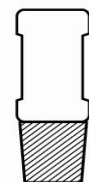

PE STOPPER	Catalogue	
	Number	Cone Size
FAVORIT , MALAYSIA	ZPPSB10	10/19
	ZPPSB12	12/21
	ZPPSB14	14/23
	ZPPSB19	19/26
	ZPPSB24	24/29
	ZPPSB29	29/32
ZPPSB34	34/35	

HIRSCHMANN, GERMANY

HAEMACYTOMETER SET - Complete	Catalogue Number
In a robust case, consisting of : 1 Counting Chamber acc. to Neubauer-improved, 2 Cover Glasses for Haemocytometer, 1 each Blood Diluting Pipette for RBC and WBC, Including Suction Tubes and Mouth Pieces.	8150101
HIRSCHMANN , GERMANY	

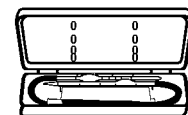

FAVORIT , MALAYSIA

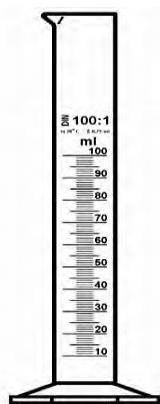

MEASURING CYLINDERS with spout Class A hexagonal base blue graduation	Catalogue Number	Volume ml	Division ml
	P813205	5	0.1
	P813210	10	0.2
	P813215	25	0.5
	P813220	50	1
	P813225	100	1
FAVORIT , MALAYSIA	P813230	250	2
	P813235	500	5
	P813240	1000	10
	P813245	2000	20

MEASURING CYLINDERS with spout Class B hexagonal base blue graduation	Catalogue Number	Volume ml	Division ml
	P813105	5	0.1
	P813110	10	0.2
	P813115	25	0.5
	P813120	50	1
	P813125	100	1
FAVORIT , MALAYSIA	P813130	250	2
	P813135	500	5
	P813140	1000	10
	P813145	2000	20

HIRSCHMANN, GERMANY

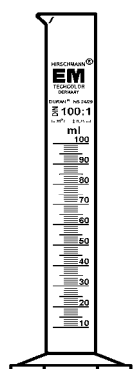

MEASURING CYLINDERS with spout Duran Class B hexagonal base blue graduation DIN EN ISO 4788	Catalogue Number	Volume ml	Division ml	Tolerance +/- ml
	2230154	5	0.1	0.075
	2230160	10	0.2	0.15
	2230170	25	0.5	0.375
	2230175	50	1	0.75
	2230180	100	1	0.75
HIRSCHMANN , GERMANY	2230186	250	2	1.5
	2230190	500	5	3.75
	2230193	1000	10	7.5
	2230194	2000	20	15

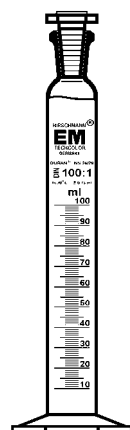

MEASURING CYLINDERS with NS Ground Joint and Poly Stopper Class B Borosilicate Glass hexagonal base blue graduation DIN EN ISO 4788	Catalogue Number	Volume ml	Division ml	Tolerance +/- ml
	2330160	10	0.2	0.15
	2330170	25	0.5	0.375
	2330175	50	1	0.75
	2330180	100	1	0.75
	2330186	250	2	1.5
	2330190	500	5	3.75
	2330193	1000	10	7.5
HIRSCHMANN , GERMANY	2330194	2000	20	15

HIRSCHMANN, GERMANY

MEASURING CYLINDERS with Spout Duran Class A Conformity Certified, ISO 9000 with Dated Batch Identification	Catalogue Number	Volume ml	Division ml	Tolerance +/- ml
hexagonal base	2210154	5	0.1	0.05
amber stain graduation	2210160	10	0.2	0.1
main point ring graduation	2210170	25	0.5	0.25
DIN EN ISO 4788	2210175	50	1	0.5
	2210180	100	1	0.5
	2210186	250	2	1
	2210190	500	5	2.5
	2210193	1000	10	5
	2210194	2000	20	10
HIRSCHMANN , GERMANY				
<i>CERTIFICATES OF PERFORMANCE</i>				
	9980101	Batch Certificate		
	9980102	Individual Certificate		

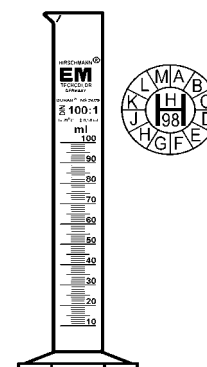

MEASURING CYLINDERS with Spout Duran Class A Conformity Certified, ISO 9000 with Dated Batch Identification Schellbach	Catalogue Number	Volume ml	Division ml	Tolerance +/- ml
hexagonal base	2220154	5	0.1	0.05
blue graduation	2220160	10	0.2	0.1
main point ring graduation	2220170	25	0.5	0.25
DIN EN ISO 4788	2220175	50	1	0.5
	2220180	100	1	0.5
	2220186	250	2	1
	2220190	500	5	2.5
	2220193	1000	10	5
	2220194	2000	20	10
HIRSCHMANN , GERMANY				
<i>CERTIFICATES OF PERFORMANCE</i>				
	9980101	Batch Certificate		
	9980102	Individual Certificate		

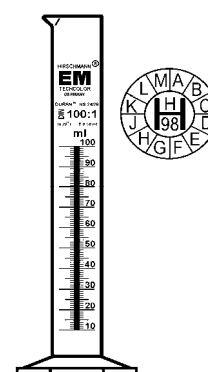

MEASURING CYLINDERS with NS Ground Joint and Poly Stopper Duran Class A Conformity Certified, ISO 9000 with Dated Batch Identification	Catalogue Number	Volume ml	Division ml	Tolerance +/- ml
hexagonal base	2340160	10	0.2	0.1
blue graduation	2340170	25	0.5	0.25
main point ring graduation	2340175	50	1	0.5
DIN EN ISO 4788	2340180	100	1	0.5
	2340186	250	2	1
	2340190	500	5	2.5
	2340193	1000	10	5
	2340194	2000	20	10
HIRSCHMANN , GERMANY				
<i>CERTIFICATES OF PERFORMANCE</i>				
	9980101	Batch Certificate		
	9980102	Individual Certificate		

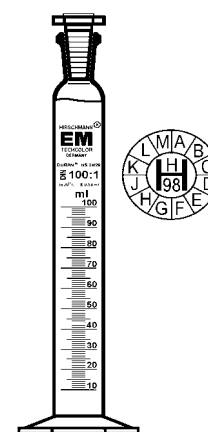

HIRSCHMANN, GERMANY

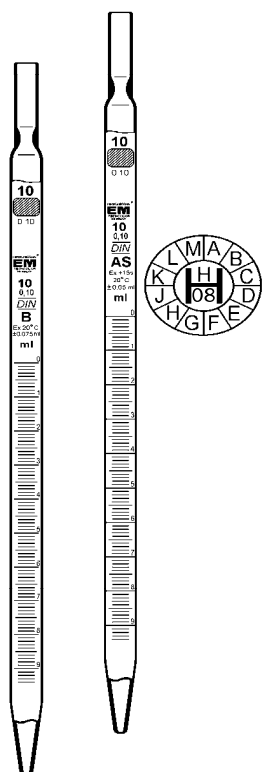

GRADUATED PIPETTES, Class AS
Conformity Certified, ISO 9000
with Dated Batch Identification
 Graduated to Tip
 amber stain graduation
 DIN EN ISO 835

HIRSCHMANN, GERMANY

Catalogue Number	Volume ml	Division ml	Tolerance +/- ml
1100129	0.5	0.01	0.005
1100133	1	0.01	0.007
1100141	2	0.02	0.01
1100153	5	0.05	0.03
1100160	10	0.1	0.05
1100165	20	0.1	0.1
1100170	25	0.1	0.1
1100175	50	0.2	0.2

CERTIFICATES OF PERFORMANCE

9980101	Batch Certificate
9980102	Individual Certificate

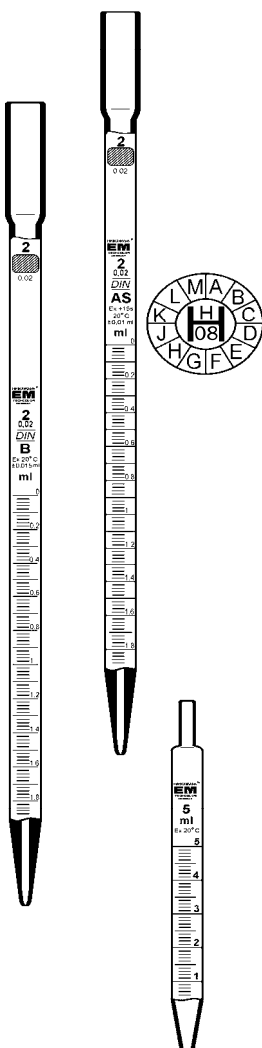

GRADUATED PIPETTES, Class B
 Graduated to Tip
 amber stain graduation
 DIN EN ISO 835

Catalogue Number	Volume ml	Division ml	Tolerance +/- ml
1000129	0.5	0.01	0.008
1000133	1	0.01	0.01
1000141	2	0.02	0.015
1000153	5	0.05	0.045
1000160	10	0.1	0.075
1000165	20	0.1	0.15
1000170	25	0.1	0.15
1000175	50	0.2	0.3

GRADUATED PIPETTES, Class AS
with Mouth Piece for Cotton Plug
Conformity Certified, ISO 9000
with Dated Batch Identification
 Graduated to Tip
 amber stain graduation
 main point ring graduation
 DIN EN ISO 835

HIRSCHMANN, GERMANY

Catalogue Number	Volume ml	Division ml	Tolerance +/- ml
1130133	1	0.01	0.007
1130141	2	0.02	0.01

CERTIFICATES OF PERFORMANCE

9980101	Batch Certificate
9980102	Individual Certificate

GRADUATED PIPETTES
with Mouth Piece for Cotton Plug
 Graduated to Tip
 amber stain graduation
 DIN EN ISO 835

HIRSCHMANN, GERMANY

Catalogue Number	Volume ml	Division ml	Tolerance +/- ml
1030133	1	0.01	0.01
1030141	2	0.02	0.015

GRADUATED PIPETTES
Tissue Culture
 with Mouth Piece for Cotton Plug
 amber stain graduation
 main point ring graduation

HIRSCHMANN, GERMANY

Catalogue Number	Volume ml	Division ml
1170135	1	0.1
1170142	2	0.1
1170154	5	0.1
1170160	10	0.1
1170171	25	0.2

HIRSCHMANN, GERMANY

VOLUMETRIC PIPETTES, Class AS
Conformity Certified, ISO 9000
with Dated Batch Identification
 One Mark
 amber stain graduation
 DIN 12691

HIRSCHMANN , GERMANY

Catalogue Number	Volume ml	Tolerance +/- ml
1340129	0.5	0.005
1340133	1	0.007
1340139	1.5	0.01
1340140	2	0.01
1340145	2.5	0.01
1340148	3	0.01
1340150	4	0.015
1340155	5	0.015
1340156	6	0.015
1340157	7	0.015
1340158	8	0.02
1340159	9	0.02
1340160	10	0.02
1340164	15	0.03
1340165	20	0.03
1340170	25	0.03
1340173	30	0.03
1340174	40	0.05
1340175	50	0.05
1340180	100	0.08

CERTIFICATES OF PERFORMANCE

9980101	Batch Certificate
9980102	Individual Certificate

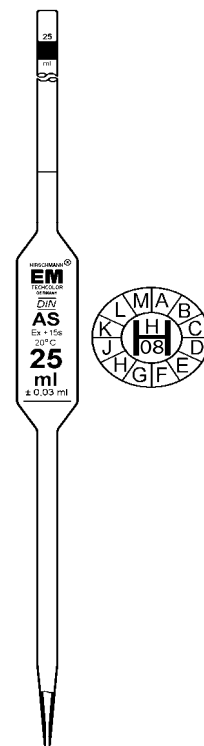

VOLUMETRIC PIPETTES, Class B
 One Mark
 amber stain graduation
 DIN 12690

HIRSCHMANN , GERMANY

Catalogue Number	Volume ml	Tolerance +/- ml
1300129	0.5	0.0075
1300133	1	0.0105
1300140	2	0.015
1300148	3	0.015
1300150	4	0.023
1300155	5	0.023
1300160	10	0.03
1300164	15	0.045
1300165	20	0.045
1300170	25	0.045
1300175	50	0.075
1300180	100	0.12

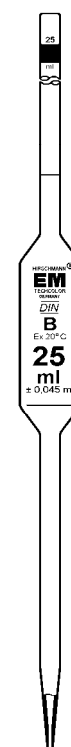

HIRSCHMANN, GERMANY

BLOOD DILUTING PIPETTES (RBC)

Acc. to Thoma for Erythrocytes
DIN 12750
HIRSCHMANN, GERMANY

Catalogue Number	Graduation
4000101	0.5 : 1 : 101

BLOOD DILUTING PIPETTES (WBC)

Acc. to Thoma for Leucocytes
DIN 12750
HIRSCHMANN, GERMANY

Catalogue Number	Graduation
4100101	0.5 : 1 : 11

HAEMOMETER PIPETTES

Acc. To Sahli, Conformity Certified
White Enamelled
Precisely Adjusted
DIN 12687
HIRSCHMANN, GERMANY

Catalogue Number	Volume ul	Tolerance +/- ul	Tot. Length +/- 10 mm
4300108	20	0.4	125

WESTERGREN TUBES 300 MM (KATZ)

Conformity Certified
DIN 12845
HIRSCHMANN, GERMANY

Catalogue Number	Type	Tot. Length +/- 10 mm
4400101	Katz 300 mm	300

WESTERGREN TUBES 305 MM

Conformity Certified
DIN 12845
HIRSCHMANN, GERMANY

Catalogue Number	Type	Tot. Length +/- 10 mm
4410101	305 mm	305

PASTEUR PIPETTES

ISO 7712
(Box of 250pcs)

HIRSCHMANN, GERMANY

Catalogue Number		Length mm
9250101	(Short Form)	150
9260101	(Long Form)	230

FAVORIT, MALAYSIA

PASTEUR PIPETTES

(Box of 250pcs)

FAVORIT, MALAYSIA

Catalogue Number		Length mm
P819150	(Short Form)	150
P819230	(Long Form)	230

DURAN, GERMANY

	Catalogue Number	Description
WATER JET PUMP with Non-Return Valve Borosilicate glass	2436299	Water Flow Rate 300 l/h Min. Water Pressure 1.2 bar Length 275 mm
DURAN , GERMANY		

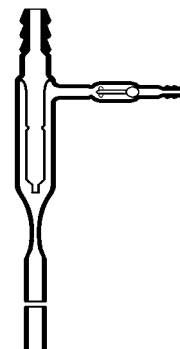

	Catalogue Number	Description
WATER JET PUMP, PP with Non-Return Valve with Hose Connection Adapter 1/2" , 3/4"	2925001	Water Flow Rate 170 l/h Min. Water Pressure 1.0 bar Length 235 mm Connection Suitable for 9-12mm ID Hose
DURAN , GERMANY		



	Catalogue Number	Capacity	Max. O.D. mm	Height
SEDIMENTATION CONE IMHOFF Type Graduated DIN 12672	2140154	1000	120	470 Max.
DURAN , GERMANY				



FAVORIT , MALAYSIA

	Catalogue Number	Description
QUARTZ CELL with LID		
FAVORIT , MALAYSIA	Pair P814010	Path Length 10mm

	Catalogue Number	Description
GLASS CELL		
FAVORIT , MALAYSIA	P814505	Path Length 5¼"

HIRSCHMANN , GERMANY



HAEMATOCRIT TUBES Disposable, Non Heparinized Length 75 mm, Color-Code Blue DIN 12846	Catalogue Number	Volume ul	O. D. mm	I. D. mm
	9100175	75	1.5 - 1.6	1.1 - 1.2

HIRSCHMANN , GERMANY

HAEMATOCRIT TUBES Disposable, Sodium Heparinized Length 75 mm, Color-Code Red DIN 12846	Catalogue Number	Volume ul	O. D. mm	I. D. mm
	9100275	75	1.5 - 1.6	1.1 - 1.2

HIRSCHMANN , GERMANY



MINICAPS Disposable micro capillary pipettes end-to-end, Not Heparinized ISO 7550, CE acc. IVD 98/79 EC	Catalogue Number	Volume ul	Length mm
	9000100	0.5	30-32
	9000101	1	30-32
	9000102	2	30-32
	9000103	3	30-32
	9001133	3.33	36
	9000104	4	30-32
	9000105	5	30-32
	9001166	6.66	72
	9000110	10	30-32
	9000120	20	30
	9000125	25	30-32
	9000130	30	30-32
	9000140	40	30
	9000144	44.7	30-32
	9000150	50	30
	9000199	100	100.00

HIRSCHMANN , GERMANY



MINICAPS Disposable micro capillary pipettes end-to-end, Sodium Heparinized ISO 7550, CE acc. IVD 98/79 EC	Catalogue Number	Volume ul	Length mm
	9000201	1	30-32
	9000202	2	30-32
	9000203	3	30-32
	9000204	4	30-32
	9000205	5	30-32
	9000210	10	30-32
	9000220	20	30
	9000225	25	30-32
	9000240	40	30
	9000244	44.7	30-32
	9000250	50	30
	9000299	100	100

HIRSCHMANN , GERMANY

HIRSCHMANN , GERMANY

CAPILLARY TUBES

Both ends open

Catalogue Number	Length mm	O. D. mm	I. D. mm
9201070	70	1.00	0.80
9201075	75	1.00	0.80
9201080	80	1.00	0.80
9201090	90	1.00	0.80
9201010	100	1.00	0.80
9201012	120	1.00	0.80
9201015	150	1.00	0.80
9201360	60	1.35	0.95
9201370	70	1.35	0.95
9201375	75	1.35	0.95
9201380	80	1.35	0.95
9201390	90	1.35	0.95
9201310	100	1.35	0.95
9201312	120	1.35	0.95
9201315	150	1.35	0.95
9201570	70	1.55	1.15
9201575	75	1.55	1.15
9201580	80	1.55	1.15
9201590	90	1.55	1.15
9201510	100	1.55	1.15
9201512	120	1.55	1.15
9201515	150	1.55	1.15
9201770	70	1.75	1.30
9201775	75	1.75	1.30
9201780	80	1.75	1.30
9201790	90	1.75	1.30
9201710	100	1.75	1.30
9201712	120	1.75	1.30
9201715	150	1.75	1.30
9202370	70	2.35	1.55
9202375	75	2.35	1.55
9202380	80	2.35	1.55
9202390	90	2.35	1.55
9202310	100	2.35	1.55
9202312	120	2.35	1.55
9202315	150	2.35	1.55

Melting Point Determination Tube

One end closed

9211070	70	1.00	0.80
9211075	75	1.00	0.80
9211080	80	1.00	0.80
9211090	90	1.00	0.80
9211010	100	1.00	0.80
9211012	120	1.00	0.80
9211015	150	1.00	0.80
9211360	60	1.35	0.95
9211370	70	1.35	0.95
9211375	75	1.35	0.95
9211380	80	1.35	0.95
9211390	90	1.35	0.95
9211310	100	1.35	0.95
9211312	120	1.35	0.95
9211315	150	1.35	0.95
9211570	70	1.55	1.15
9211575	75	1.55	1.15
9211580	80	1.55	1.15
9211590	90	1.55	1.15
9211510	100	1.55	1.15
9211512	120	1.55	1.15
9211515	150	1.55	1.15
9211770	70	1.75	1.30
9211775	75	1.75	1.30
9211780	80	1.75	1.30
9211790	90	1.75	1.30
9211710	100	1.75	1.30
9211712	120	1.75	1.30
9211715	150	1.75	1.30
9212370	70	2.35	1.55
9212375	75	2.35	1.55
9212380	80	2.35	1.55
9212390	90	2.35	1.55
9212310	100	2.35	1.55
9212312	120	2.35	1.55
9212315	150	2.35	1.55



DURAN, GERMANY



STAINING JAR, Coplin Type
for 10 Microscope Slides 76 x 26 mm
Soda-Lime Glass
DURAN, GERMANY

Catalogue Number	O. D. x Height mm
2331900	45 x 105

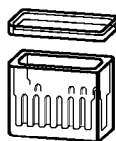

STAINING DISH, Hellendahl Type
for 16 Microscope Slides 76 x 26 mm
Soda-Lime Glass
DURAN, GERMANY

Catalogue Number	H x L x W mm
2331400	95 x 85 x 35

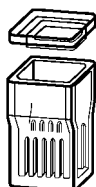

STAINING DISH, Hellendahl Type with Wide Upper Section
for 16 Microscope Slides 76 x 26 mm
Soda-Lime Glass
DURAN, GERMANY

Catalogue Number	H x L x W mm
2331500	105 x 60 x 55

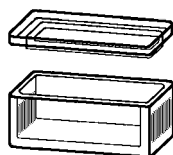

STAINING DISH, Schiefferdecker Type
for 10 Microscope Slides 76 x 26 mm
Soda-Lime Glass
DURAN, GERMANY

Catalogue Number	H x L x W mm
2331600	45 x 85 x 70

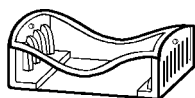

STAINING TRAY
for 10 Microscope Slides 76 x 26 mm
or any Width up to 52 mm
Soda-Lime Glass
DURAN, GERMANY

Catalogue Number	H x L x W mm
2131700	45 x 85 x 30

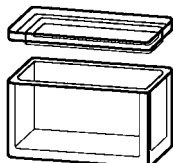

GLASS BOX
with Cover for Staining Tray
Soda-Lime Glass
DURAN, GERMANY

Catalogue Number	H x L x W mm
2331800	70 x 105 x 85

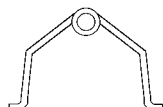

STAINLESS STEEL HANDLE
for Staining Tray
DURAN, GERMANY

Catalogue Number
2907500

FAVORIT, MALAYSIA

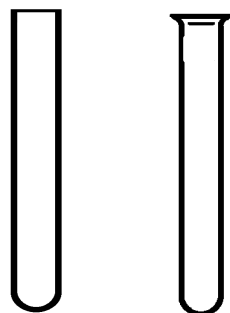

TEST TUBE
- for medical use
FAVORIT, MALAYSIA

Catalogue Number	O.D. x Height mm
Rimless	
P801203	10 x 75
P801208	12 x 75
P801211	12 x 100
P801212	13 x 100

Rimless	
P801216	16 x 125
P801233	25 x 150

with Rim	
P801234	25 x 150

DURAN, GERMANY

TEST TUBES, with Beaded Rim	Catalogue Number	ml	O.D. x Length mm
	DURAN , GERMANY	2613001	2
2613003		4	10 x 75
2613006		5	10 x 100
2613008		6	12 x 75
2613011		8	12 x 100
2613013		16	14 x 130
2613016		20	16 x 130
2613021		25	16 x 160
2613023		35	18 x 180
2613026		39	20 x 150
2613028		45	20 x 180
2613033		60	25 x 150
2613036		80	25 x 200
2613038	110	30 x 200	

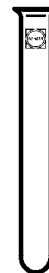

TEST TUBES, Rimless (Straight Rim)	Catalogue Number	ml	O.D. x Length mm
	DURAN , GERMANY	2613101	2
2613103		4	10 x 75
2613106		5	10 x 100
2613108		6	12 x 75
2613111		8	12 x 100
2613113		16	14 x 130
2613116		20	16 x 130
2613121		25	16 x 160
2613123		35	18 x 180
2613126		39	20 x 150
2613128		45	20 x 180
2613133		60	25 x 150
2613136		80	25 x 200
2613138		110	30 x 200



AR GLASS CULTURE TUBES Disposable, soda-lime glass with PP screw-cap and white rubber gasket (suitable for food use) DURAN , GERMANY	Catalogue Number	DIN Thread GL	O. D. x Length mm
	23175115	14	12 x 100, 6ml
	23175145	18	16 x 100, 12ml
	23175215	18	16 x 160, 22ml
	23175235	18	18 x 180, 32ml



NMR TUBES three accuracy classes height 178mm DURAN , GERMANY	Catalogue Number	OD mm	Camber mm	MHZ
	Economic			
	231700117	4.95 ± 0.05	0.07	300
	Professional			
	231700211	4.97 ± 0.025	0.03	400
Scientific				
231700314	4.97 ± 0.025	0.013	500	



FAVORIT , MALAYSIA

TEST TUBES, Graduated	Catalogue Number	Capacity ml	O. D. x Length mm	
	FAVORIT , MALAYSIA	P801110	10	17 x 100
		P801125	25	22 x 125
		P801150	50	28 x 150



TEST TUBES, with Screw Cap	Catalogue Number	Capacity ml	DIN Thread GL	
	FAVORIT , MALAYSIA	P801310	10	14
		P801325	25	18
		P801350	50	25

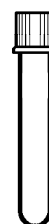

FAVORIT , MALAYSIA

CENTRIFUGE TUBES Round Bottom thick-walled & very resistant to mechanical loading	Catalogue Number	Capacity ml	O.D. x Height mm	WT mm
	P802210	6	12 x 100	2.2
	P802211	12	16 x 100	1.8
	P802214	25	24 x 100	2.5
	P802217	50	34 x 100	2.8
	P802224	80	40 x 115	3.2
FAVORIT , MALAYSIA	P802226	80	44 x 100	3.2
	P802236	250	56 x 147	3.5

CENTRIFUGE TUBE Conical, Angle 30° thick-walled & very resistant to mechanical loading	Catalogue Number	Capacity ml	O.D. x Height mm	WT mm
FAVORIT , MALAYSIA	P802309	12	16 x 100	1.2

CENTRIFUGE TUBES Conical, Angle 60° thick-walled & very resistant to mechanical loading	Catalogue Number	Capacity ml	O.D. x Height mm	WT mm
FAVORIT , MALAYSIA	P802414	25	24 x 100	1.4
	P802417	50	34 x 100	1.4

CENTRIFUGE TUBES Round Bottom Graduated	Catalogue Number	Capacity ml	Description
FAVORIT , MALAYSIA	P802110	10 ml	17 x 100mm
	P802125	25 ml	24 x 100mm
	P802150	50 ml	34 x 100mm

CENTRIFUGE TUBES Long Conical	Catalogue Number	Description
FAVORIT , MALAYSIA	P802515	Vol. 15 ml
	P802520	Vol. 15 ml, Graduated 0 - 10 ml
	P802525	Vol. 15 ml, Graduated 0 - 15 ml

MOJONNIER TUBES with rubber stopper	Catalogue Number	Description
FAVORIT , MALAYSIA	P803102	with Round Bulb
	P803101	with Flat Bulb

NESSLER TUBES	Catalogue Number	Description
FAVORIT , MALAYSIA	P804150	50 ml
JAYTEC / UK	FRJ-SP.1337	100ml

CENTRIFUGE TUBES Long Conical	Catalogue Number	Description
HIRSCHMANN , GERMANY	6000101	Vol. 15 ml
	6010101	Vol. 15 ml, Graduated 0 - 10 ml
	6020101	Vol. 15 ml, Graduated 0 - 15 ml

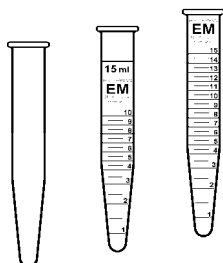
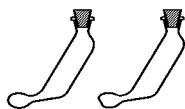
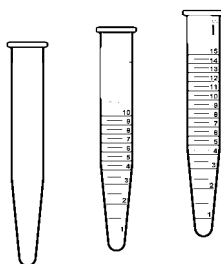
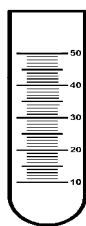
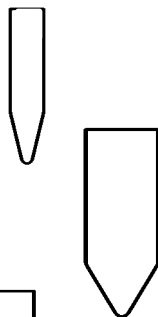
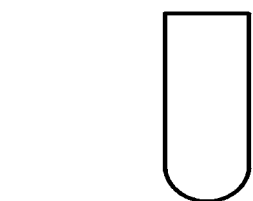

S.MURRAY , UK

SPECIMEN TUBES	Catalogue Number	Size mm
Flat Bottom	G050/20	50 x 12/13
with Push In Polythene Stoppers	G050/22	75 x 12/13
S. MURRAY , U.K.	G050/23	100 x 12/13
	G050/26	50 x 18/19
	G050/27	75 x 18/19
	G050/28	50 x 25/26
	G050/29	75 x 25/26
	G050/30	100 x 25/26
	G050/31	150 x 25/26

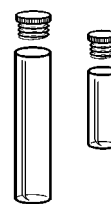

DURHAM TUBES	Catalogue Number	Size mm
S. MURRAY , U.K.	G010/22	30 x 6.5
	G010/23	35 x 7.5
	G010/24	50 x 7.5

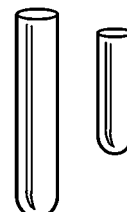

FAVORIT , MALAYSIA

	Catalogue Number	Capacity ml	Tube Size mm
DIGESTION TUBES	JTT75/26	75	26 x 255
Plain	JTT100/26	100	26 x 300
FAVORIT , MALAYSIA	JTT250/42	250	42 x 300
DIGESTION TUBES	JTK75/26	75	26 x 255
Kjeldahl Style, Non-Graduated	JTK100/26	100	26 x 300
FAVORIT , MALAYSIA	JTK250/42	250	42 x 300
DIGESTION TUBES	JTK75/26G	75	26 x 255
Kjeldahl Style, Graduated	JTK100/26G	100	26 x 300
FAVORIT , MALAYSIA	JTK250/42G	250	42 x 300

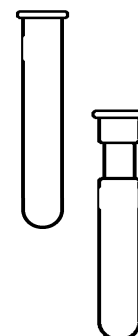

DIGESTION TUBES	Catalogue Number	Capacity ml	Tube Size mm
Buchi type	JTB48/260	250	48 x 260
FAVORIT , MALAYSIA	JTB48/300	250	48 x 300

FAVORIT , MALAYSIA

REDUCTION ADAPTERS	Catalogue Number	Socket Size	Cone Size
FAVORIT , MALAYSIA	JDA01	10/19	14/23
	JDA12	14/23	19/26
	JDA13	14/23	24/29
	JDA14	14/23	29/32
	JDA23	19/26	24/29
	JDA24	19/26	29/32
	JDA25	19/26	34/35
	JDA26	19/26	40/38
	JDA27	19/26	45/40
	JDA34	24/29	29/32
	JDA35	24/29	34/35
	JDA36	24/29	40/38
	JDA37	24/29	45/40
	JDA38	24/29	50/42
	JDA39	24/29	55/44
	JDA45	29/32	34/35
	JDA47	29/32	45/40
	JDA56	34/35	40/38
JDA57	34/35	45/40	
JDA58	34/35	50/42	

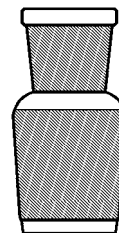

EXPANSION ADAPTERS	Catalogue Number	Socket Size	Cone Size
FAVORIT , MALAYSIA	JXA10	14/23	10/19
	JXA21	19/26	14/23
	JXA31	24/29	14/23
	JXA32	24/29	19/26
	JXA41	29/32	14/23
	JXA42	29/32	19/26
	JXA43	29/32	24/29
	JXA52	34/35	19/26
	JXA53	34/35	24/29
	JXA54	34/35	29/32
	JXA64	40/38	29/32
	JXA74	45/40	29/32

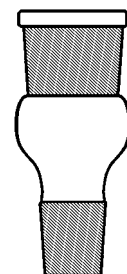

MULTIPLE ADAPTERS Two Necks Parallel	Catalogue Number	Socket Size	Cone Size
FAVORIT , MALAYSIA	JMA1/00	10/19	10/19
	JMA1/11	14/23	14/23
	JMA1/2	19/26	19/26
	JMA1/3	19/26	24/29
	JMA1/5	19/26	34/35
	JMA1/33	24/29	24/29
	JMA1/44	29/32	29/32

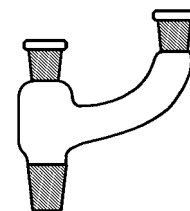

MULTIPLE ADAPTERS Two Necks One Vertical and One at 45-Degree FAVORIT	Catalogue Number	Socket Size	Cone Size
FAVORIT	JMA2/2	19/26	19/26
	JMA2/3	19/26	24/29

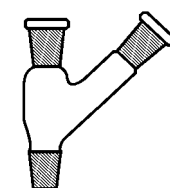

MULTIPLE ADAPTERS Three Necks Two Parallel and One at 45-Degree FAVORIT , MALAYSIA	Catalogue Number	Socket Size	Cone Size	
FAVORIT , MALAYSIA	JMA4/13	19/26	14/23	24/29
	JMA4/23	19/26	19/26	24/29
	JMA4/24	19/26	19/26	29/32
	JMA4/25	19/26	19/26	34/35
	JMA4/29	19/26	19/26	55/44

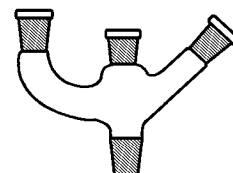

SWAN NECK ADAPTERS for use with Thermometers (6 - 7 mm O.D.) or Air Leak Tubes FAVORIT , MALAYSIA	Catalogue Number	Socket Size	Cone Size	
FAVORIT , MALAYSIA	JMA6/11	14/23	14/23	GL 14
	JMA6/22	19/26	19/26	GL 14
	JMA6/23	19/26	24/29	GL 14
	JMA6/33	24/29	24/29	GL 14

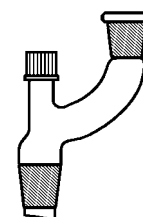

FAVORIT , MALAYSIA

CONE/FLEXIBLE TUBING ADAPTERS Right-Angle Connection	Catalogue Number	Cone Size	O/D of Olive mm
	FAVORIT , MALAYSIA	JMF10/0B	10/19
	JMF10/1B	14/23	9
	JMF10/2B	19/26	9
	JMF10/3B	24/29	9
	JMF10/4B	29/32	9
	JMF10/5B	34/35	9

SOCKET/FLEXIBLE TUBING ADAPTERS Straight Connection	Catalogue Number	Socket Size	O/D of Olive mm
	FAVORIT , MALAYSIA	JMF13/1	14/23
	JMF13/2	19/26	9
	JMF13/3	24/29	9
	JMF13/4	29/32	9

SOCKET/CONE ADAPTERS with 'T' Connection	Catalogue Number	Socket Size	Cone Size
	FAVORIT , MALAYSIA	JMF17/1	14/23
	JMF17/2	14/23	19/26
	JMF17/3	14/23	24/29
	JMF18/2	19/26	19/26
	JMF18/3	19/26	24/29
	JMF18/4	19/26	29/32
	JMF18/5	19/26	34/35
	JMF18/33	24/29	24/29
	JMF18/34	24/29	29/32
	JMF18/44	29/32	29/32

CONE/SCREWTHREAD ADAPTERS Straight allow the incorporation of Thermometers, Gas Inlet Tubes etc	Catalogue Number	Thread Size	Cone Size	Insert Tube Dia. mm
	FAVORIT , MALAYSIA	JST51/13	GL 14	14/23
	JST52/13	GL 14	19/26	6 - 7
	JST53/13	GL 14	24/29	6 - 7
	JST54/13	GL 14	29/32	6 - 7
	JST55/13	GL 14	34/35	6 - 7
	JST51/18	GL 18	14/23	7 - 8.5
	JST52/18	GL 18	19/26	7 - 8.5
	JST53/18	GL 18	24/29	7 - 8.5
	JST54/18	GL 18	29/32	7 - 8.5
	JST55/18	GL 18	34/35	7 - 8.5
	JST52/24	GL 25	19/26	10.5 - 11.5
	JST53/24	GL 25	24/29	10.5 - 11.5
	JST54/24	GL 25	29/32	10.5 - 11.5
	JST55/24	GL 25	34/35	10.5 - 11.5
	JST54/28	GL 32	29/32	18 - 19
	JST55/28	GL 32	34/35	18 - 19

SCREWTHREAD ADAPTERS T' Connectors	Catalogue Number	Thread Size	App. Limb Lgth mm	App. Cap Dia. mm
	FAVORIT , MALAYSIA	JSQ1/13	GL 14	35
	JSQ1/18	GL 18	35	7.0 - 8.5
	JSQ1/24	GL 25	40	10.5 - 11.5
	JSQ1/28	GL 32	50	18.0 - 19.0

SCREWTHREAD ADAPTERS Straight Connectors	Catalogue Number	Thread Size	App. Limb Lgth mm	App. Cap Dia. mm
	FAVORIT , MALAYSIA	JSQ4/13	GL 14	85
	JSQ4/18	GL 18	85	7.0 - 8.5
	JSQ4/24	GL 25	100	10.5 - 11.5
	JSQ4/28	GL 32	120	18.0 - 19.0

FAVORIT , MALAYSIA

CONE/FLEXIBLE TUBING STOPCOCK ADAPTERS	Catalogue Number	Cone Size	O/D of Olive mm	Stopcock Bore mm
Straight Connection	JMF11/1	14/23	9	3
GP Vendura Key	JMF11/2	19/26	9	3
	JMF11/3	24/29	9	3
FAVORIT , MALAYSIA	JMF11/4	29/32	9	3



CONE/FLEXIBLE TUBING STOPCOCK ADAPTERS	Catalogue Number	Cone Size	O/D of Olive mm	Stopcock Bore mm
Right-angled Connection	JMF11/1B	14/23	9	3
GP Vendura Key	JMF11/2B	19/26	9	3
	JMF11/3B	24/29	9	3
FAVORIT , MALAYSIA	JMF11/5B	34/35	9	3

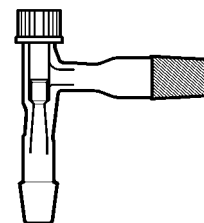

SOCKET/FLEXIBLE TUBING STOPCOCK ADAPTERS	Catalogue Number	Cone Size	O/D of Olive mm	Stopcock Bore mm
Straight Connection	JMF14/1	14/23	9	3
GP Vendura Key	JMF14/2	19/26	9	3
FAVORIT , MALAYSIA	JMF14/3	24/29	9	3



CONE/SOCKET STOPCOCK ADAPTERS	Catalogue Number	Cone Size	Socket Size	Stopcock Bore mm
GP Vendura Key	JEF6T/33	24/29	24/29	10
FAVORIT , MALAYSIA	JEF6T/55	34/35	34/35	10



STOPCOCK ADAPTERS with Vacuum Release and Control Stopcock	Catalogue Number	Type	Socket Size	Stopcock Bore mm
GP Vendura Key	JTF6/24/2VR	Release	19/26	10
FAVORIT , MALAYSIA	JTF6/24/2	Control	19/26	10

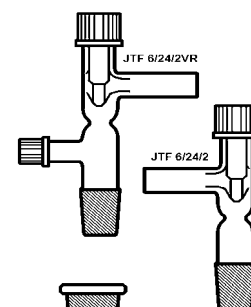

CHROMATOGRAPHY STOPCOCK ADAPTER	Catalogue Number	Socket Size	Cone Size	Approx. O/all Height mm
GP Vendura Key	JCR3T/23	19/26	24/29	190
FAVORIT , MALAYSIA				



FAVORIT , MALAYSIA

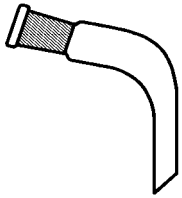

PLAIN BENDS, SHORT STEM - RECEIVER ADAPTERS

	Catalogue Number	Socket Size	Approx. Stem Length mm
	JRA1/01	14/23	65
FAVORIT , MALAYSIA	JRA1/02	19/26	65
	JRA1/03	24/29	65
	JRA1/04	29/32	65

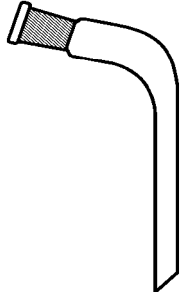

PLAIN BENDS, LONG STEM - RECEIVER ADAPTERS

	Catalogue Number	Socket Size	Approx. Stem Length mm
	JRA1/10	10/19	120
FAVORIT , MALAYSIA	JRA1/11	14/23	190
	JRA1/12	19/26	200
	JRA1/13	24/29	200
	JRA1/14	29/32	200



STRAIGHT DELIVERY ADAPTERS - RECEIVER ADAPTERS

	Catalogue Number	Socket Size	Approx. Overall Height mm
	JRA1/21	14/23	180
FAVORIT , MALAYSIA	JRA1/22	19/26	180
	JRA1/23	24/29	180
	JRA1/24	29/32	180
	JRA1/25	34/35	180

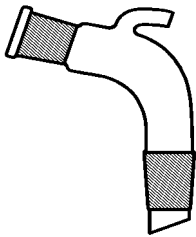

BENDS WITH VENTS - RECEIVER ADAPTERS

	Catalogue Number	Socket Size	Cone Size	Approx. Overall Height mm
	JRA2/00	10/19	10/19	75
FAVORIT , MALAYSIA	JRA2/11	14/23	14/23	80
	JRA2/22	19/26	19/26	100
	JRA2/23	19/26	24/29	120
	JRA2/33	24/29	24/29	130
	JRA2/44	29/32	29/32	140

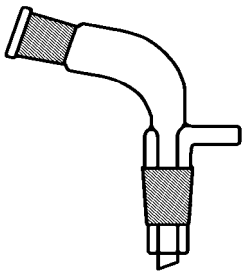

BENDS WITH VACUUM CONNECTION - RECEIVER ADAPTERS

	Catalogue Number	Socket Size	Cone Size	Approx. Overall Height mm
	JRA3/11	14/23	14/23	110
	JRA3/22	19/26	19/26	140
	JRA3/23	19/26	24/29	140
FAVORIT , MALAYSIA	JRA3/33	24/29	24/29	150
	JRA3/44	29/32	29/32	165

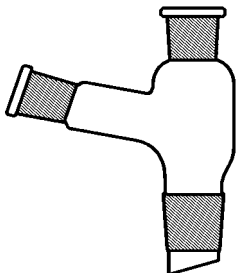

BENDS, SOCKET TO CONE with Vertical Socket - RECEIVER ADAPTERS

	Catalogue Number	Socket Size	Cone Size	Approx. Overall Height mm
	JRA4/11	14/23	14/23	120
	JRA4/22	19/26	19/26	120
FAVORIT , MALAYSIA	JRA4/23	19/26	24/29	120

FAVORIT , MALAYSIA

BENDS WITH MULTIPLE CONNECTIONS - RECEIVER ADAPTERS	Catalogue Number	Socket Size	Cone Size	Approx. Overall Height mm
	JRA5/00	10/19	10/19	65
	JRA5/11	14/23	14/23	110
	JRA5/21	19/26	14/23	110

FAVORIT , MALAYSIA

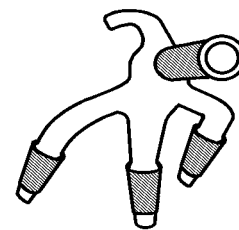

PERKIN RECEIVERS (INTERMEDIATE RECEIVERS) - RECEIVER ADAPTERS	Catalogue Number	Socket Size	Cone Size	Minimum Capacity ml
	JRA6/11	14/23	14/23	10
GP Vendura Stopcocks	JRA6/22	19/26	19/26	32
	JRA6/23	19/26	24/29	32
FAVORIT , MALAYSIA	JRA6/33	24/29	24/29	32

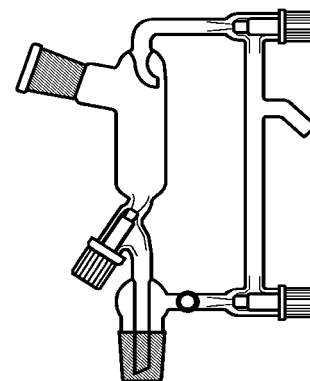

PLAIN BENDS, SOCKET TO CONE - RECEIVER ADAPTERS	Catalogue Number	Socket Size	Cone Size	Approx. Overall Height mm
	JRA9/11	14/23	14/23	90
	JRA9/22	19/26	19/26	100
FAVORIT , MALAYSIA	JRA9/23	19/26	24/29	110
	JRA9/33	24/29	24/29	125
	JRA9/44	29/32	29/32	140
	JRA9/55	34/35	34/35	155

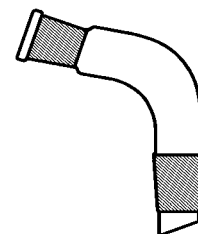

MULTI-LIMB VACUUM RECEIVERS - RECEIVER ADAPTERS	Catalogue Number	Socket Size	Cone Size	Description
	JRA11	19/26	14/23	Vac. receiver adapter - 4 flasks
FAVORIT , MALAYSIA	JRA11/2	19/26	19/26	Vertical delivery adapter
	JRA12/2	19/26	19/26	Sloping delivery adapter
	JFR25/1S	14/23	-----	25 ml flask
	JFR50/1S	14/23	-----	50 ml flask
	JFR100/1S	14/23	-----	100 ml flask



JRA 12/2

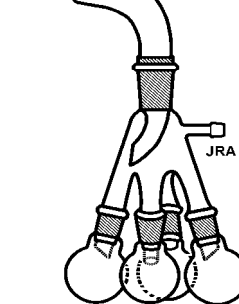

JRA 11



JRA 11/2

VERTICAL RECEIVER ADAPTER with VACUUM CONNECTION	Catalogue Number	Socket Size	Cone Size	Approx. Overall Height mm
	JRA13/33	24/29	24/29	140

FAVORIT , MALAYSIA

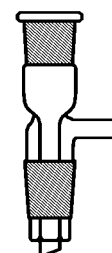

FAVORIT , MALAYSIA

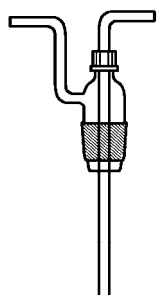

DRESCHEL BOTTLE HEAD - Adjustable	Catalogue Number	Cone Size	Thread Size	To Fit Bottle
	JMF27/3/13	24/29	GL 14	JMF 29/3/125 JMF 29/3/250

FAVORIT , MALAYSIA

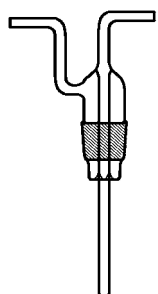

DRESCHEL BOTTLE HEADS - Plain	Catalogue Number	Cone Size	App. Stem Length mm	To Fit Bottle
	JMF28/2	19/26	175	-
	JMF28/3/125	24/29	130	JMF 29/3/125
FAVORIT , MALAYSIA	JMF28/3/250	24/29	175	JMF 29/3/250
	JMF28/3/500	24/29	215	JMF 29/3/500

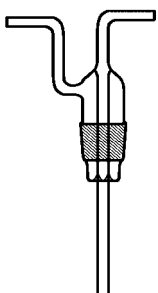

DRESCHEL BOTTLE HEADS - Sintered	Catalogue Number	Porosity	Cone Size	App. Stem Length mm	To Fit Bottle
	JMF48/13/125	1	24/29	130	JMF 29/3/125
	JMF48/13/250	1	24/29	165	JMF 29/3/250
FAVORIT , MALAYSIA	JMF48/13/500	1	24/29	215	JMF 29/3/500
	JMF48/23/250	2	24/29	165	JMF 29/3/250
	JMF48/23/500	2	24/29	215	JMF 29/3/500
	JMF48/33/250	3	24/29	165	JMF 29/3/250

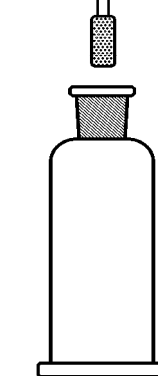

DRESCHEL GAS WASHING BOTTLES	Catalogue Number	Capacity ml	Socket Size	App. Overall Height mm
	JMF29/3/125	125	24/29	155
	JMF29/3/250	250	24/29	190
FAVORIT , MALAYSIA	JMF29/3/500	500	24/29	245

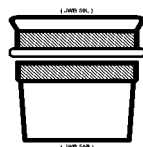

WEIGHING BOTTLE	Catalogue Number	Description	Max. Wt. g	Min. Capacity ml
Joint Size 50/14	JWB50L	Lid	25	-
FAVORIT , MALAYSIA	JWB50B	Base	30	58

FAVORIT , MALAYSIA

COLD TRAP (ABSORPTION TRAP)	Catalogue	Description	Socket	Cone
	Number			
FAVORIT , MALAYSIA	JMF24/5	Trap Body Overall Length 250 mm	34/35	-
	JMF28/52	Trap Head	19/26	34/35 & 19/26

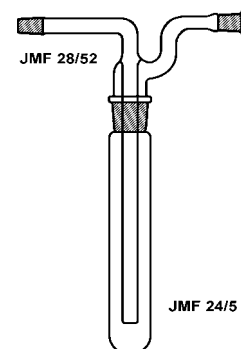

COLD TRAPS	Catalogue	Description	Socket	Cone
	Number			
FAVORIT , MALAYSIA	JCT13/250	Cold Trap 250 ml	24/29	-
	JCT14/250	Cold Trap 250 ml	29/32	-
	JCT13/500	Cold Trap 500 ml	24/29	-
	JCT14/500	Cold Trap 500 ml	29/32	-
	JCT2/33	90 Deg. Bend	-	24/29
	JCT2/44	90 Deg. Bend	-	29/32
	JCT3/33	U-Bend with GP Vendura Stopcock	-	24/29

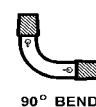
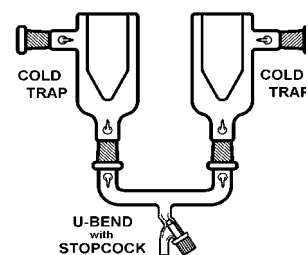

FAVORIT , MALAYSIA

CHROMATOGRAPHY COLUMNS
with Porosity O Sintered Disc
and PTFE Stopcock
Nominal Bore 10 mm
FAVORIT , MALAYSIA

Catalogue Number	App. Effect. Lgth mm	Socket Size	Cone Size
JCR12/10/PT	100	14/23	19/26
JCR12/30/PT	300	14/23	19/26

CHROMATOGRAPHY COLUMNS
with Porosity O Sintered Disc
and PTFE Stopcock
FAVORIT , MALAYSIA

Catalogue Number	App. Effect. Lgth mm	Diameter mm	Socket Size
JCR10/10/PT	100	10	14/23
JCR10/20/PT	200	10	14/23
JCR10/30/PT	300	10	14/23
JCR10/40/PT	400	10	14/23
JCR20/10/PT	100	20	19/26
JCR20/20/PT	200	20	19/26
JCR20/30/PT	300	20	19/26
JCR20/40/PT	400	20	19/26
JCR20/50/PT	500	20	19/26
JCR30/30/PT	300	25	24/29
JCR30/40/PT	400	25	24/29
JCR30/50/PT	500	25	24/29
JCR40/30/PT	300	30	29/32
JCR40/40/PT	400	30	29/32
JCR40/50/PT	500	30	29/32
JCR50/40/PT	400	30	34/35
JCR50/50/PT	500	30	34/35
JCR60/40/PT	400	40	40/38
JCR60/50/PT	500	40	40/38

CHROMATOGRAPHY COLUMNS
with Porosity O Sintered Disc
and GP Vendura Stopcock
Nominal Bore 10 mm
FAVORIT , MALAYSIA

Catalogue Number	App. Effect. Lgth mm	Socket Size	Cone Size
JCR12/10	100	14/23	19/26
JCR12/30	300	14/23	19/26

CHROMATOGRAPHY COLUMNS
with Porosity O Sintered Disc
and GP Vendura Stopcock
FAVORIT , MALAYSIA

Catalogue Number	App. Effect. Lgth mm	Diameter mm	Socket Size
JCR10/10	100	10	14/23
JCR10/20	200	10	14/23
JCR10/30	300	10	14/23
JCR10/40	400	10	14/23
JCR20/10	100	20	19/26
JCR20/20	200	20	19/26
JCR20/30	300	20	19/26
JCR20/40	400	20	19/26
JCR20/50	500	20	19/26
JCR30/30	300	25	24/29
JCR30/40	400	25	24/29
JCR30/50	500	25	24/29
JCR40/30	300	30	29/32
JCR40/40	400	30	29/32
JCR40/50	500	30	29/32
JCR50/40	400	30	34/35
JCR50/50	500	30	34/35
JCR60/40	400	40	40/38
JCR60/50	500	40	40/38

FAVORIT , MALAYSIA

CHROMATOGRAPHY COLUMNS with Porosity O Sintered Disc Nominal Bore 20 mm	Catalogue	App. Effect.	Socket	Cone
	Number	Lgth mm	Size	Size
	JCR32/20	200	24/29	19/26
	JCR32/30	300	24/29	19/26
FAVORIT , MALAYSIA	JCR32/40	400	24/29	19/26

FRACTIONATING COLUMNS Plain	Catalogue	Socket	Cone	App. Effect.
	Number	Size	Size	Lgth mm
	JFC7/23	24/29	24/29	250
	JFC7/43	24/29	24/29	500
FAVORIT , MALAYSIA	JFC7/44	29/32	29/32	500
	JFC7/53	24/29	24/29	750
	JFC8/23	34/35	24/29	270
	JFC8/43	34/35	24/29	520

FRACTIONATING COLUMNS Vigreux	Catalogue	Socket	Cone	App. Effect.
	Number	Size	Size	Lgth mm
	JFC3/13	24/29	24/29	360
FAVORIT , MALAYSIA	JFC3/23	24/29	24/29	600
	JFC3/14	29/32	29/32	360

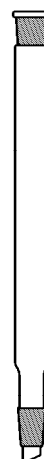

FAVORIT , MALAYSIA

LIEBIG CONDENSERS	Catalogue Number	Socket Size	Cone Size	App. Effect. Lgth mm
FAVORIT , MALAYSIA	JC1/00	10/19	10/19	60
	JC1/11	14/23	14/23	160
	JC1/12	19/26	19/26	200
	JC1/12/25	19/26	19/26	250
	JC1/13/20	24/29	24/29	200
	JC1/13	24/29	24/29	250
	JC1/14/25	29/32	29/32	250
	JC1/22/35	19/26	19/26	350
	JC1/22	19/26	19/26	400
	JC1/23/30	24/29	24/29	300
	JC1/23/35	24/29	24/29	350
	JC1/23	24/29	24/29	400
	JC1/44	29/32	29/32	400
	JC1/55	34/35	34/35	500

AIR CONDENSERS	Catalogue Number	Socket Size	Cone Size	App. Effect. Lgth mm
FAVORIT , MALAYSIA	JC2/00	10/19	10/19	100
	JC2/11	14/23	14/23	200
	JC2/12	19/26	19/26	150
	JC2/22	19/26	19/26	400
	JC2/32	19/26	19/26	600
	JFC7/13	24/29	24/29	200
	JFC7/23	24/29	24/29	250
	JFC7/33	24/29	24/29	300
	JFC7/43	24/29	24/29	500
	JFC7/53	24/29	24/29	750
	JFC7/44	29/32	29/32	500
	JFC7/45	34/35	34/35	500

AIR CONDENSERS for use with Block Heater Glassware	Catalogue Number	Socket Size	Cone Size	App. Effect. Lgth mm
FAVORIT , MALAYSIA	JC2/1	-	14/23	150
	JC2/2	-	19/26	750
	JC2/3	-	24/29	510
	JC2/3/1	-	24/29	750
	JC2/3/2	-	24/29	1500
	JC2/4	-	29/32	750
	JC2/6	-	40/38	740

GRAHAM COIL CONDENSERS	Catalogue Number	Socket Size	Cone Size	App. Effect. Lgth mm
FAVORIT , MALAYSIA	JC3/12	19/26	19/26	160
	JC3/13	24/29	24/29	160
	JC3/14	29/32	29/32	160
	JC3/22	19/26	19/26	300
	JC3/23	24/29	24/29	300
	JC3/24	29/32	29/32	300
	JCX3/04	-	29/32	150
	JCX3/05	-	34/35	160
	JCX3/06	-	40/38	200
	JCX3/07	-	45/40	200
	JCX3/08	-	50/42	155

MULTI-COIL CONDENSERS	Catalogue Number	Socket Size	Cone Size	App. Effect. Lgth mm
FAVORIT , MALAYSIA	JC4/12	19/26	19/26	200
	JC4/13	24/29	24/29	200
	JC13/55	34/35	34/35	230
	JC13/55/2	34/35	34/35	420

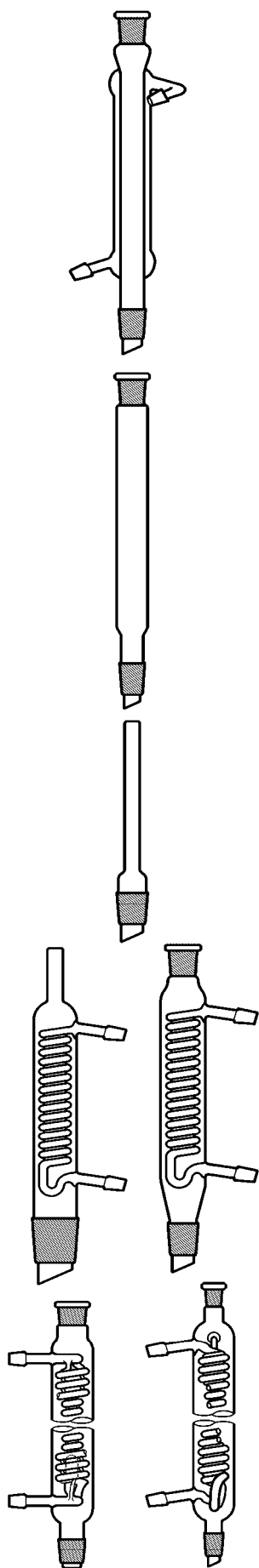

FAVORIT , MALAYSIA

DOUBLE-SURFACE CONDENSERS (DAVIES CONDENSERS)		Catalogue Number	Socket Size	Cone Size	App. Effect. Lgth mm
FAVORIT , MALAYSIA		JC5/10	10/19	10/19	100
		JC5/11	14/23	14/23	150
		JC5/12	19/26	19/26	150
		JC5/13	24/29	24/29	150
		JC5/22	19/26	19/26	200
		JC5/23	24/29	24/29	200
		JC5/24	29/32	29/32	200
		JC5/25	34/35	34/35	200
		JC5/55	34/35	34/35	500
		JCX5/23	-	24/29	200
		JCX5/25	-	34/35	200

INLAND REVENUE CONDENSERS		Catalogue Number	Socket Size	Cone Size	App. Effect. Lgth mm
FAVORIT , MALAYSIA		JC6/12	19/26	19/26	200
		JC6/13	24/29	24/29	200

ETHER CONDENSER		Catalogue Number	Socket Size	Cone Size	App. Effect. Lgth mm
FAVORIT , MALAYSIA		JC11/23	19/26	24/29	180

REVERSIBLE COIL CONDENSERS		Catalogue Number	Cone Sizes	App. Effect. Lgth mm
FAVORIT , MALAYSIA		JCX3/23	19/26 & 24/29	160
		JCX3/35	24/29 & 34/35	160

JACKETED COIL CONDENSERS		Catalogue Number	Socket Size	Cone Size	App. Effect. Lgth mm
FAVORIT , MALAYSIA		JCX6/22	19/26	19/26	160
		JCX6/33	24/29	24/29	160
		JCX6/44	29/32	29/32	160
		JCX6/05	-	34/35	160
		JCX6/06	-	40/38	160

ALLIHN CONDENSERS		Catalogue Number	Socket Size	Cone Size	App. Effect. Lgth mm
FAVORIT , MALAYSIA		JCX7/02	-	19/26	250
		JCX7/03	-	24/29	250
		JCX7/04	-	29/32	250
		JCX7/05	-	34/35	250
		JCX7/06	-	40/38	250
		JCX7/08	-	50/42	250
		JCX7/33	24/29	24/29	400
		JCX7/44	29/32	29/32	400

IMMERSION CONDENSER (DEPHLEGMATOR)		Catalogue Number	Socket Size	Cone Size	App. Effect. Lgth mm
FAVORIT , MALAYSIA		JFC14/00	-	19/26	100

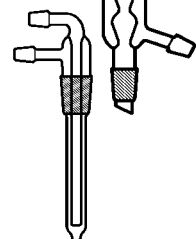
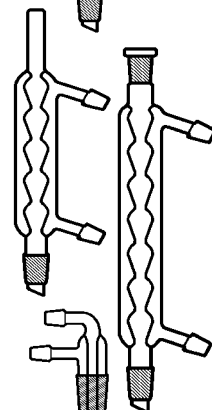
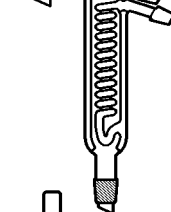
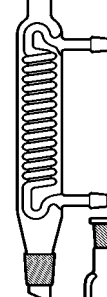
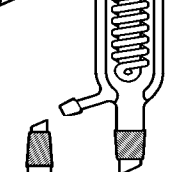
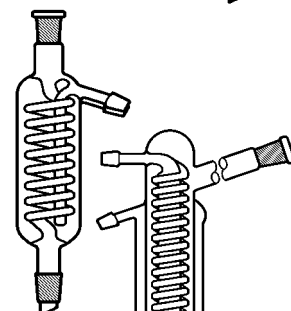
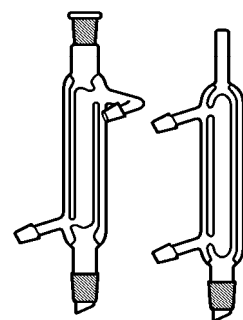

FAVORIT , MALAYSIA

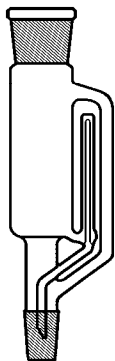

SOXHLET EXTRACTORS	Catalogue Number	Socket/Flange Size	Cone Size	Nom. Cap. ml
FAVORIT , MALAYSIA	JEX5/21	19/26	14/23	6
	JEX5/32	24/29	19/26	20
	JEX5/43	29/32	24/29	40
	JEX5/53	34/35	24/29	60
	JEX5/55	34/35	34/35	60
	JEX5/55/100	34/35	34/35	100
	JEX5/63	40/38	24/29	100
	JEX5/83	50/42	24/29	200
	JEX5/75/5	75 mm	34/35	600
	JEX5/100/5	100 mm	34/35	2000

LID for SOXHLET EXTRACTOR with flat flange joints	Catalogue Number	Flange Size	Socket Size
FAVORIT , MALAYSIA	JDA5/75	75 mm	34/35
	JDA5/100	100 mm	34/35

RETAINING CLIPS for Soxhlet Extractor lids Stainless Steel	Catalogue Number	for Flange Size
	JJC75F	75 mm
	JJC100F	100 mm



BUCHNER FILTER FUNNELS with Porosity 3 Sintered Disc	Catalogue Number	Cone Size	App. Disc Dia. mm	App. Funnel Dia. mm
FAVORIT , MALAYSIA	JSF3A32	19/26	50	70
	JSF3A33	24/29	50	70
	JSF3A34	29/32	50	70
	JSF3B33	24/29	90	105

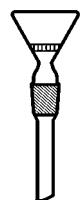

CONICAL FILTER FUNNELS with Porosity 3 Sintered Disc	Catalogue Number	Cone Size	App. Disc Dia. mm	App. Funnel Dia. mm
FAVORIT , MALAYSIA	JSF4A32	19/26	20	45
	JSF4B32	19/26	30	80

SEMI-MICRO FILTER FUNNELS with Porosity 3 Sintered Disc	Catalogue Number	Cone Size	App. Disc Dia. mm	App. Funnel Dia. mm
FAVORIT , MALAYSIA	JSF4T30	10/19	10	30
	JSF4T31	14/23	10	30

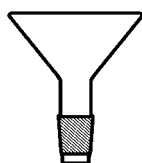

POWDER FUNNELS	Catalogue Number	Cone Size	App. Funnel Dia. mm
FAVORIT , MALAYSIA	JCF5/1	14/23	105
	JCF5/2	19/26	105
	JCF5/3	24/29	105
	JCF5/4	29/32	105
	JCF5/5	34/35	105

FAVORIT , MALAYSIA

REACTION FLASKS wide neck with flat flange joints	Catalogue	Nominal	Flange	Flask	App. Overall
	Number	capacity	Bore	Shape	Height
		ml	mm		mm
	JFR250F	250	75	Spherical	90
	JFR500F	500	75	Spherical	115
FAVORIT , MALAYSIA	JFR700F	700	100	Cylindrical	135
	JFR1LF	1000	100	Spherical	155
	JFR2LF	2000	100	Spherical	185
	JFR3LF	3000	100	Spherical	210
	JFR4LF	4000	100	Spherical	225
	JFR5LF	5000	100	Spherical	245
	JFR6LF	6000	100	Spherical	260
	JFR10LF	10000	100	Spherical	320
	JFR20LF	20000	100	Spherical	380

LIDS for Wide Neck Flasks with flat flange joints	Catalogue Number	Flange Bore mm	Vertical Centre Socket	Side Sockets			
				0'	5'	10'	15'
	JDA5/75	75	34/35	-----	-----	-----	-----
FAVORIT , MALAYSIA	JDA4/100	100	29/32	-----	-----	-----	-----
	JDA5/100	100	34/35	-----	-----	-----	-----
	JMAF1/75	75	19/26	14/23	19/26	19/26	19/26
	JMAF2/41	100	19/26	14/23	14/23	14/23	29/32
	JMAF2/52	100	19/26	19/26	19/26	19/26	34/35
	JMAF3/52	100	24/29	19/26	19/26	19/26	34/35
	JMAF4/41	100	29/32	14/23	14/23	14/23	29/32
	JMAF2/32	100	19/26	19/26	24/29	19/26	-----
	JMAF2/2	100	19/26	19/26	2 x 19/26	19/26	-----
	JMAF5/2	100	34/35	19/26	-----	2 x 19/26	-----

RETAINING CLIPS for wide neck flask lids stainless steel	Catalogue	for Flange
	Number	
	JJC75F	75 mm
	JJC100F	100 mm

QUICK RELEASE CLAMP for DN Flange stainless steel	Catalogue	for DN Flange
	Number	
	2907134	DN60
	2907146	DN100
	2907151	DN120

FAVORIT , MALAYSIA

JACKETED REACTION VESSELS with flat flange joint	Catalogue	Nominal	Flange	App. Overall	Side
	Number	Capacity ml	Bore mm	Height mm	Arms OD mm
	JJRV1L	1000	100	228	12
FAVORIT , MALAYSIA	JJRV2L	2000	100	312	12

CULTURE VESSELS with flat flange joint	Catalogue	Nominal	Flange	App. Overall
	Number	Capacity ml	Bore mm	Height mm
	JFV500	500	75	130
FAVORIT , MALAYSIA	JFV1L	1000	100	160
	JFV2L	2000	100	225

FAVORIT , MALAYSIA

FLAT BOTTOM FLASKS Short Neck		Catalogue Number	Nominal Capacity ml	Socket Size
FAVORIT , MALAYSIA		JFF50/2S	50	19/26
		JFF50/3S	50	24/29
		JFF50/4S	50	29/32
		JFF50/5S	50	34/35
		JFF100/2S	100	19/26
		JFF100/3S	100	24/29
		JFF100/4S	100	29/32
		JFF100/5S	100	34/35
		JFF150/2S	150	19/26
		JFF150/3S	150	24/29
		JFF150/4S	150	29/32
		JFF150/5S	150	34/35
		JFF250/2S	250	19/26
		JFF250/3S	250	24/29
		JFF250/4S	250	29/32
		JFF250/5S	250	34/35
		JFF500/2S	500	19/26
		JFF500/3S	500	24/29
		JFF500/4S	500	29/32
		JFF500/5S	500	34/35
		JFF1L/3US	1000	24/29
		JFF1L/4S	1000	29/32
		JFF1L/5S	1000	34/35
		JFF2L/3S	2000	24/29
		JFF2L/4S	2000	29/32
		JFF2L/5S	2000	34/35
		JFF4L/7S	4000	45/40



FLAT BOTTOM FLASKS Medium Neck		Catalogue Number	Nominal Capacity ml	Socket Size
FAVORIT , MALAYSIA		JFF100/3M	100	24/29
		JFF150/3M	150	24/29
		JFF250/2M	250	19/26
		JFF250/3M	250	24/29
		JFF250/4M	250	29/32
		JFF500/3UM	500	24/29
		JFF500/4UM	500	29/32
		JFF1L/3M	1000	24/29
		JFF1L/4M	1000	29/32
		JFF2L/5M	2000	34/35



FLORENTINE FLASKS		Catalogue Number	Nominal Capacity ml	Socket Size
FAVORIT , MALAYSIA		JFD50/4/RE	50	29/32
		JFD100/3	100	24/29
		JFD100/4/RE	100	29/32
		JFD250/3	250	24/29
		JFD250/4/RE	250	29/32
		JFD500/3	500	24/29
		JFD500/4/RE	500	29/32
		JFD1L/3	1000	24/29
		JFD1L/4/RE	1000	29/32
		JFD2L/3	2000	24/29

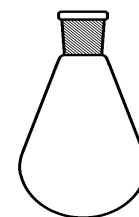

KJELDAHL FLASKS		Catalogue Number	Nominal Capacity ml	Socket Size	Description
FAVORIT , MALAYSIA		JMC22/50	50	19/26	Round Bottom
		JMC44/50	50	29/32	Round Bottom
		JMC22/100	100	19/26	Round Bottom
		JFK100/3L	100	24/29	Kjeldahl Shape
		JFK300/3L	300	24/29	Kjeldahl Shape
		JFK500/3L	500	24/29	Kjeldahl Shape
		JFK750/3L	750	24/29	Kjeldahl Shape

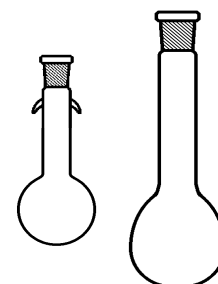

FAVORIT , MALAYSIA

ROUND BOTTOM FLASKS**Short Neck**

FAVORIT , MALAYSIA

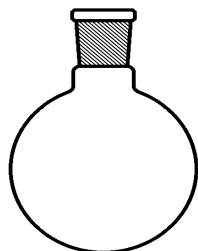

Catalogue Number	Nominal Capacity ml	Socket Size
JFR5/0S	5	10/19
JFR5/1S	5	14/23
JFR10/0S	10	10/19
JFR10/1S	10	14/23
JFR25/0S	25	10/19
JFR25/1S	25	14/23
JFR25/2S	25	19/26
JFR25/3S	25	24/29
JFR50/1S	50	14/23
JFR50/2S	50	19/26
JFR50/3S	50	24/29
JFR50/5S	50	34/35
JFR100/1S	100	14/23
JFR100/2S	100	19/26
JFR100/3S	100	24/29
JFR100/4S	100	29/32
JFR100/5S	100	34/35
JFR150/2S	150	19/26
JFR150/3S	150	24/29
JFR150/4S	150	29/32
JFR150/5S	150	34/35
JFR250/1S	250	14/23
JFR250/2S	250	19/26
JFR250/3S	250	24/29
JFR250/4S	250	29/32
JFR250/5S	250	34/35
JFR500/2S	500	19/26
JFR500/3S	500	24/29
JFR500/4S	500	29/32
JFR500/5S	500	34/35
JFR500/7S	500	45/40
JFR1L/2S	1000	19/26
JFR1L/3S	1000	24/29
JFR1L/4S	1000	29/32
JFR1L/5S	1000	34/35
JFR1L/7S	1000	45/40
JFR1L/9S	1000	55/44
JFR2L/3S	2000	24/29
JFR2L/4S	2000	29/32
JFR2L/5S	2000	34/35
JFR3L/3S	3000	24/29
JFR3L/5S	3000	34/35
JFR3L/7S	3000	45/40
JFR4L/7S	4000	45/40
JFR5L/4S	5000	29/32
JFR5L/5S	5000	34/35
JFR5L/7S	5000	45/40
JFR5L/9S	5000	55/44
JFR6L/7S	6000	45/40
JFR10L/5S	10000	34/35

ROUND BOTTOM FLASKS**Medium Neck**

FAVORIT , MALAYSIA

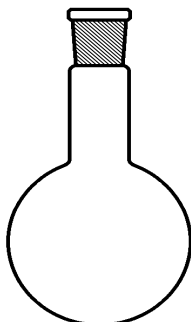

Catalogue Number	Nominal Capacity ml	Socket Size
JFR50/1M	50	14/23
JFR50/2M	50	19/26
JFR50/3M	50	24/29
JFR100/1M	100	14/23
JFR100/2M	100	19/26
JFR100/3M	100	24/29
JFR150/3M	150	24/29
JFR250/2M	250	19/26
JFR250/3M	250	24/29
JFR500/3M	500	24/29
JFR500/4M	500	29/32
JFR500/5M	500	34/35
JFR1L/3UM	1000	24/29
JFR1L/4UM	1000	29/32
JFR1L/5UM	1000	34/35
JFR2L/3UM	2000	24/29
JFR2L/4UM	2000	29/32
JFR2L/5UM	2000	34/35

ROUND BOTTOM FLASKS Two Necks	Catalogue Number	Nominal Capacity ml	Centre Socket Size	Side Socket Size
	JFR25/0S/0A	25	10/19	10/19
	JFR25/1S/1A	25	14/23	14/23
	JFR25/3S/2A	25	24/29	19/26
	JFR50/1S/1A	50	14/23	14/23
	JFR50/3S/2A	50	24/29	19/26
Centre Neck and One Angled Side Neck	JFR100/3S/1A	100	24/29	14/23
	JFR100/3S/2A	100	24/29	19/26
	JFR250/3S/1A	250	24/29	14/23
FAVORIT , MALAYSIA	JFR250/3S/2A	250	24/29	19/26
	JFR500/3S/1A	500	24/29	14/23
	JFR500/3S/2A	500	24/29	19/26
	JFR1L/3S/1A	1000	24/29	14/23
	JFR1L/3S/2A	1000	24/29	19/26
	JFR1L/5S/2A	1000	34/35	19/26
	JFR2L/5S/2A	2000	34/35	19/26

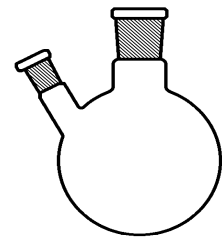

ROUND BOTTOM FLASKS Three Necks	Catalogue Number	Nominal Capacity ml	Centre Socket Size	Side Socket Size
Centre Neck and Two Angled Side Necks	JFR100/2S/11A	100	19/26	14/23
	JFR100/3S/11A	100	24/29	14/23
	JFR100/3S/22A	100	24/29	19/26
	JFR250/2S/22A	250	19/26	19/26
FAVORIT , MALAYSIA	JFR250/3S/11A	250	24/29	14/23
	JFR250/3S/22A	250	24/29	19/26
	JFR250/4S/11A	250	29/32	14/23
	JFR250/4S/22A	250	29/32	19/26
	JFR500/3S/11A	500	24/29	14/23
	JFR500/3S/22A	500	24/29	19/26
	JFR500/4S/11A	500	29/32	14/23
	JFR500/4S/22A	500	29/32	19/26
	JFR1L/3S/11A	1000	24/29	14/23
	JFR1L/3S/22A	1000	24/29	19/26
	JFR1L/4S/22A	1000	29/32	19/26
	JFR1L/4S/44A	1000	29/32	29/32
	JFR1L/5S/22A	1000	34/35	19/26
	JFR2L/3US/22A	2000	24/29	19/26
	JFR2L/5S/22A	2000	34/35	19/26
	JFR3L/5S/22A	3000	34/35	19/26

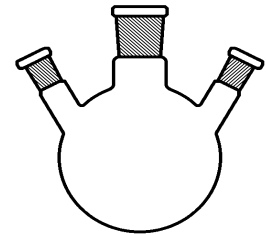

ROUND BOTTOM FLASKS Three Necks Parallel	Catalogue Number	Nominal Capacity ml	Centre Socket Size	Side Socket Size
All Necks Parallel	JFR250/3S/22P	250	24/29	19/26
	JFR250/4S/11P	250	29/32	14/23
	JFR500/3S/22P	500	24/29	19/26
FAVORIT , MALAYSIA	JFR500/4S/11P	500	29/32	14/23
	JFR500/4S/22P	500	29/32	19/26
	JFR1L/3S/22P	1000	24/29	19/26
	JFR1L/4S/22P	1000	29/32	19/26
	JFR1L/5S/22P	1000	34/35	19/26
	JFR1L/5S/33P	1000	34/35	24/29
	JFR1L/7S/22P	1000	45/40	19/26
	JFR2L/3US/22P	2000	24/29	19/26
	JFR2L/4S/22P	2000	29/32	19/26
	JFR2L/4S/44P	2000	29/32	29/32
	JFR2L/5S/22P	2000	34/35	19/26
	JFR2L/5S/33P	2000	34/35	24/29
	JFR2L/7S/44P	2000	45/40	29/32
	JFR3L/5S/22P	3000	34/35	19/26
	JFR3L/5S/33P	3000	34/35	24/29
	JFR4L/7S/44P	4000	45/40	29/32
	JFR5L/5US/33P	5000	34/35	24/29
	JFR6L/7S/44P	6000	45/40	29/32

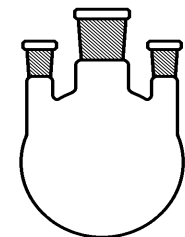

PEAR SHAPE FLASKS Single Neck		Catalogue Number	Nominal Capacity ml	Socket Size
FAVORIT , MALAYSIA		JFP5/0	5	10/19
		JFP5/1	5	14/23
		JFP10/0	10	10/19
		JFP10/1	10	14/23
		JFP25/0	25	10/19
		JFP25/1	25	14/23
		JFP50/1	50	14/23
		JFP50/2	50	19/26
		JFP100/1	100	14/23
		JFP100/2	100	19/26
	JFP100/3	100	24/29	

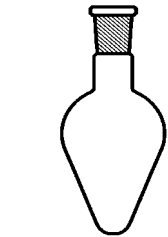

PEAR SHAPE FLASKS Two Necks		Catalogue Number	Nominal Capacity ml	Centre Socket Size	Side Socket Size
Centre Neck and One Angled Side Neck		JFP25/0/0A	25	10/19	10/19
		JFP25/1/1A	25	14/23	14/23
		JFP50/0/0A	50	10/19	10/19
		JFP50/1/1A	50	14/23	14/23

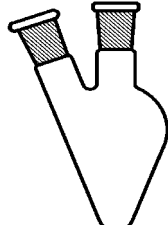

PEAR SHAPE FLASKS Three Necks		Catalogue Number	Nominal Capacity ml	Centre Socket Size	Side Socket Size
Centre Neck with One Parallel Side Neck and One Angled Side Neck		JFP25/0/AP	25	10/19	10/19
		JFP50/1/AP	50	14/23	14/23

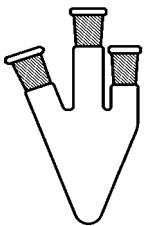

PEAR SHAPE FLASKS Distillation		Catalogue Number	Nominal Capacity ml	Socket Size	Cone Size
FAVORIT , MALAYSIA		JMD2/10	10	14/23	14/23
		JMD2/25	25	14/23	14/23
		JMD2/50	50	14/23	14/23
		JMD2/100	100	14/23	14/23

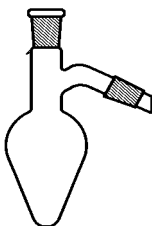

PEAR SHAPE FLASKS Claisen		Catalogue Number	Nominal Capacity ml	Socket Size	Cone Size
FAVORIT , MALAYSIA		JMD3/10	10	14/23	14/23
		JMD3/0/25	25	10/19	10/19
		JMD3/25	25	14/23	14/23
		JMD3/50	50	14/23	14/23
		JMD3/100	100	14/23	14/23

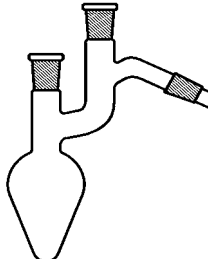

PEAR SHAPE FLASKS Claisen-Vigreux		Catalogue Number	Nominal Capacity ml	Socket Size	Cone Size
FAVORIT , MALAYSIA		JMD4/25	25	14/23	14/23
		JMD4/50	50	14/23	14/23
		JMD4/100	100	14/23	14/23

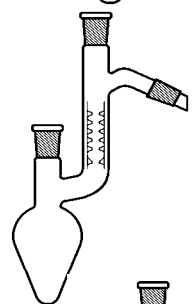

PEAR SHAPE FLASKS Vigreux with Angled Side Neck		Catalogue Number	Nominal Capacity ml	Main Socket Size	Side Socket Size	Side Cone Size
FAVORIT , MALAYSIA		JMD7/10	10	14/23	10/19	14/23
		JMD7/25	25	14/23	10/19	14/23
		JMD7/50	50	14/23	10/19	14/23

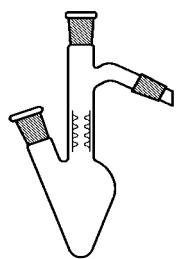

CONICAL FLASKS (ERLENMEYER FLASKS)		Catalogue Number	Nominal Capacity ml	Socket Size
FAVORIT , MALAYSIA		JFE5/0	5	10/19
		JFE5/1	5	14/23
		JFE10/0	10	10/19
		JFE10/1	10	14/23
		JFE25/0	25	10/19
		JFE25/1	25	14/23
		JFE25/2	25	19/26
		JFE50/1	50	14/23
		JFE50/2	50	19/26
		JFE50/3	50	24/29
		JFE100/1	100	14/23
		JFE100/2	100	19/26
		JFE100/3	100	24/29
		JFE100/4	100	29/32
		JFE150/2	150	19/26
		JFE150/3	150	24/29
		JFE150/4	150	29/32
		JFE200/2	200	19/26
		JFE200/3	200	24/29
		JFE200/4	200	29/32
		JFE250/2	250	19/26
		JFE250/3	250	24/29
		JFE250/4	250	29/32
		JFE250/5	250	34/35
		JFE500/2	500	19/26
		JFE500/3	500	24/29
		JFE500/4	500	29/32
	JFE500/5	500	34/35	
	JFE1L/3	1000	24/29	
	JFE1L/4	1000	29/32	
	JFE1L/5	1000	34/35	
	JFE2L/3	2000	24/29	
	JFE2L/4	2000	29/32	
	JFE2L/5	2000	34/35	

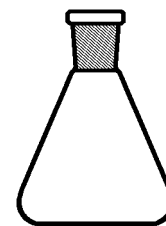

BUCHNER FILTER FLASKS with Glass Side-Arm		Catalogue Number	Nominal Capacity ml	Socket Size
DURAN, GERMANY		JFB100/2	100	19/26
		JFB100/3	100	24/29
		JFB250/3	250	24/29
		JFB250/4	250	29/32
		JFB500/3	500	24/29
		JFB500/4	500	29/32
		JFB1L/3	1000	24/29
		JFB1L/4	1000	29/32

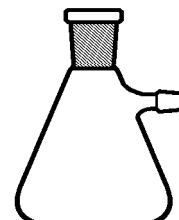

IODINE FLASKS		Catalogue Number	Nominal Capacity ml	Joint Size	Min. Cup Capacity ml
FAVORIT , MALAYSIA		JFIB250/3	250	24/29	20
		JFIB250/4	250	29/32	20
		JFIB500/3	500	24/29	20
		JFIB500/4	500	29/32	20

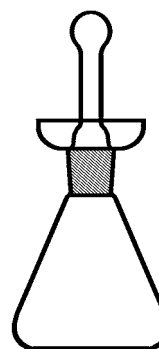

IODINE FLASK STOPPERS		Catalogue Number	Joint Size
FAVORIT		JSIB24	24/29
		JSIB29	29/32

FAVORIT , MALAYSIA

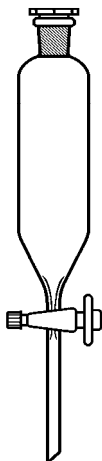
CYLINDRICAL FUNNELS
with PTFE Stopcock
and PE Stopper

FAVORIT , MALAYSIA

Catalogue Number	Nominal Capacity ml	Socket Size
JD41/50/PT	50	14/23
JD42/50/PT	50	19/26
JD42/100/PT	100	19/26
JD42/250/PT	250	19/26
JD42/500/PT	500	19/26
JD43/100/PT	100	24/29
JD43/250/PT	250	24/29
JD43/500/PT	500	24/29

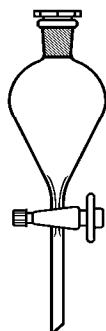
PEAR SHAPE FUNNELS
with PTFE Stopcock
and PE Stopper

FAVORIT , MALAYSIA

Catalogue Number	Nominal Capacity ml	Socket Size
JD52/50/PT	50	19/26
JD52/100/PT	100	19/26
JD52/250/PT	250	19/26
JD52/500/PT	500	19/26
JD53/100/PT	100	24/29
JD53/250/PT	250	24/29
JD53/500/PT	500	24/29
JD54/500/PT	500	29/32
JD22/1L/PT	1000	19/26
JD23/1L/PT	1000	24/29
JD24/1L/PT	1000	29/32
JD24/2L/PT	2000	29/32
JD25/2L/PT	2000	34/35

CYLINDRICAL FUNNELS
with PTFE Spindle Stopcock
and PE Stopper

FAVORIT , MALAYSIA

Catalogue Number	Nominal Capacity ml	Socket Size
JD41/50	50	14/23
JD42/50	50	19/26
JD42/100	100	19/26
JD42/250	250	19/26
JD42/500	500	19/26
JD43/250	250	24/29
JD43/500	500	24/29

PEAR SHAPE FUNNELS
with PTFE Spindle Stopcock
and PE Stopper

FAVORIT , MALAYSIA

Catalogue Number	Nominal Capacity ml	Socket Size
JD52/50	50	19/26
JD52/100	100	19/26
JD52/250	250	19/26
JD52/500	500	19/26
JD53/100	100	24/29
JD53/250	250	24/29
JD53/500	500	24/29
JD54/500	500	29/32
JD22/1L	1000	19/26
JD23/1L	1000	24/29
JD24/1L	1000	29/32
JD24/2L	2000	29/32
JD25/2L	2000	34/35

FAVORIT , MALAYSIA

CYLINDRICAL FUNNELS Stem with Cone with PTFE Stopcock and PE Stopper	Catalogue Number	Nominal Capacity ml	Socket & Cone Size
	JD1/11/PT	50	14/23
	JD1/21/PT	100	14/23
	JD1/22/PT	100	19/26
FAVORIT , MALAYSIA	JD1/32/PT	250	19/26
	JD1/42/PT	500	19/26
	JD1/62/PT	1000	19/26



PEAR SHAPE FUNNELS Stem with Cone with PTFE Stopcock and PE Stopper	Catalogue Number	Nominal Capacity ml	Socket & Cone Size
	JD2/01/PT	25	14/23
	JD2/11/PT	50	14/23
	JD2/12/PT	50	19/26
	JD2/21/PT	100	14/23
FAVORIT , MALAYSIA	JD2/22/PT	100	19/26
	JD2/31/PT	250	14/23
	JD2/32/PT	250	19/26
	JD2/42/PT	500	19/26
	JD2/43/PT	500	24/29
	JD2/62/PT	1000	19/26

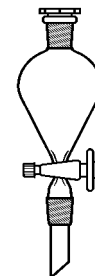

CYLINDRICAL FUNNELS Stem with Cone with Glass Stopcock and PE Stopper	Catalogue Number	Nominal Capacity ml	Socket & Cone Size
	JD1/11/GL	50	14/23
	JD1/21/GL	100	14/23
	JD1/22/GL	100	19/26
	JD1/32/GL	250	19/26
FAVORIT , MALAYSIA	JD1/42/GL	500	19/26
	JD1/62/GL	1000	19/26

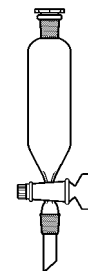

PEAR SHAPE FUNNELS Stem with Cone with Glass Stopcock and PE Stopper	Catalogue Number	Nominal Capacity ml	Socket & Cone Size
	JD2/01/GL	25	14/23
	JD2/11/GL	50	14/23
	JD2/12/GL	50	19/26
	JD2/21/GL	100	14/23
FAVORIT , MALAYSIA	JD2/22/GL	100	19/26
	JD2/31/GL	250	14/23
	JD2/32/GL	250	19/26
	JD2/42/GL	500	19/26
	JD2/43/GL	500	24/29
	JD2/62/GL	1000	19/26

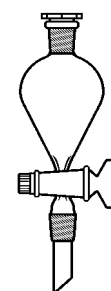

FAVORIT , MALAYSIA



CYLINDRICAL FUNNELS Stem with Cone with PTFE Spindle Stopcock and PE Stopper	Catalogue Number	Nominal Capacity ml	Socket and Cone Size
	JD1/11	50	14/23
	JD1/21	100	14/23
	JD1/22	100	19/26
FAVORIT , MALAYSIA	JD1/32	250	19/26
	JD1/42	500	19/26
	JD1/62	1000	19/26



PEAR SHAPE FUNNELS Stem with Cone with PTFE Spindle Stopcock and PE Stopper	Catalogue Number	Nominal Capacity ml	Socket and Cone Size
	JD2/01	25	14/23
	JD2/11	50	14/23
	JD2/12	50	19/26
FAVORIT , MALAYSIA	JD2/21	100	14/23
	JD2/22	100	19/26
	JD2/31	250	14/23
	JD2/32	250	19/26
	JD2/42	500	19/26
	JD2/43	500	24/29
	JD2/62	1000	19/26



CYLINDRICAL FUNNELS Stem Inside Cone with PTFE Stopcock or PTFE Spindle Stopcock and PE Stopper	Catalogue Number	Nominal Capacity ml	Socket & Cone Size
	JD31/1/50	50	14/23
	JD31/1/100	100	14/23
	JD31/2/100	100	19/26
	JD31/2/250	250	19/26
FAVORIT , MALAYSIA	JD31/2/500	500	19/26
	JD31/2/1L	1000	19/26

FAVORIT , MALAYSIA

OPEN TOP FUNNELS Stem Inside Cone	Catalogue Number	Nominal Capacity ml	Cone Size
with PTFE Stopcock	JD3/12	50	19/26
or PTFE Spindle Stopcock	JD3/22	100	19/26
	JD3/32	250	19/26

FAVORIT , MALAYSIA



OPEN TOP FUNNELS	Catalogue Number	Nominal Capacity ml	Cone Size
with PTFE Stopcock	JD62/50PT	50	19/26
or PTFE Spindle Stopcock	JD62/50GP	50	19/26

FAVORIT , MALAYSIA



CYLINDRICAL FUNNELS Pressure Equalising	Catalogue Number	Nom. Cap. ml	Socket Size	Cone Size
with PTFE Stopcock	JDEC500/32	500	24/29	19/26
or PTFE Spindle Stopcock and PE Stopper	JDEC500/33	500	24/29	24/29
	JDEC500/44	500	29/32	29/32

FAVORIT , MALAYSIA

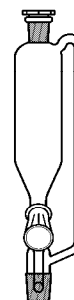

PEAR SHAPE FUNNELS Pressure Equalising	Catalogue Number	Nom. Cap. ml	Socket Size	Cone Size
with PTFE Stopcock	JDE100/22	100	19/26	19/26
or PTFE Spindle Stopcock and PE Stopper	JDE100/32	100	24/29	19/26
	JDE100/44	100	29/32	29/32
	JDE250/32	250	24/29	19/26
	JDE250/33	250	24/29	24/29
	JDE250/44	250	29/32	29/32
	JDE250/55	250	34/35	34/35

FAVORIT , MALAYSIA

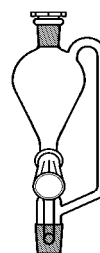

LARGE CAPACITY FUNNEL (Chromatography Reservoir)	Catalogue Number	Nom. Cap. ml	Socket Size	Cone Size
with PTFE Spindle Stopcock and PE Stopper	JCR1/535	5000	34/35	24/29
with PTFE Stopcock and PE Stopper	JCR1/535PT	5000	34/35	24/29

FAVORIT , MALAYSIA



FAVORIT , MALAYSIA

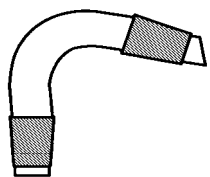

RECOVERY BENDS Sloping	Catalogue Number	Cone Size To Fit Flask	Cone Size To Fit Condenser
FAVORIT , MALAYSIA	JSH1/11	14/23	14/23
	JSH1/22	19/26	19/26
	JSH1/23	24/29	19/26
	JSH1/33	24/29	24/29
	JSH1/24	29/32	19/26
	JSH1/44	29/32	29/32
	JSH1/25	34/35	19/26
	JSH1/35	34/35	24/29

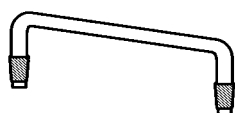

RECOVERY BENDS Vertical	Catalogue Number	Cone Size To Fit Flask	Cone Size To Fit Condenser
FAVORIT , MALAYSIA	JSH2/11	14/23	14/23
	JSH2/22	19/26	19/26
	JSH2/23	24/29	19/26
	JSH2/33	24/29	24/29
	JSH2/55	34/35	34/35

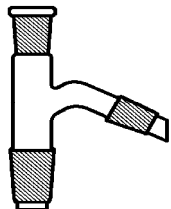

PLAIN STILLHEADS with Thermometer Socket	Catalogue Number	Cone Size To Fit Flask	Cone Size To Fit Condenser	Socket Size
FAVORIT , MALAYSIA	JSH4/0	10/19	10/19	10/19
	JSH4/1	14/23	14/23	14/23
	JSH4/22	19/26	19/26	14/23
	JSH4/2	19/26	19/26	19/26
	JSH4/23	24/29	19/26	14/23
	JSH4/33	24/29	24/29	14/23
	JSH4/24	29/32	19/26	14/23
	JSH4/44	29/32	29/32	14/23
	JSH4/25	34/35	19/26	14/23
	JSH4/35	34/35	24/29	14/23
	JSH4/55	34/35	34/35	14/23

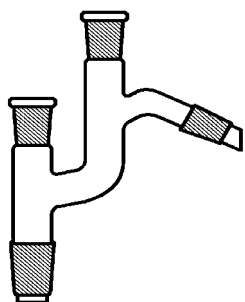

CLAISEN HEADS Sloping	Catalogue Number	Cone Size To Fit Flask	Cone Size To Fit Condenser	Socket Size
FAVORIT , MALAYSIA	JSH6/1	14/23	14/23	14/23
	JSH6/22	19/26	19/26	14/23
	JSH6/23	24/29	19/26	14/23
	JSH6/33	24/29	24/29	14/23
	JSH6/44	29/32	29/32	14/23
	JSH6/25	34/35	19/26	14/23

FAVORIT , MALAYSIA

SPLASH HEAD ADAPTER	Catalogue Number	Socket Size	Cone Size
FAVORIT , MALAYSIA	JSH17/23	19/26	24/29



SPLASH HEADS, Sloping	Catalogue Number	Cone Size To Fit Flask	Cone Size To Fit Condenser
FAVORIT , MALAYSIA	JSH7/02	19/26	19/26
	JSH7/03	24/29	19/26
	JSH7/43	24/29	24/29
	JSH7/0/44	29/32	29/32
	JSH7/0/25	34/35	19/26
	JSH7/0/55	34/35	34/35

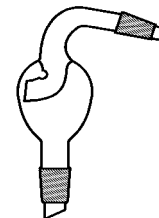

SPLASH HEADS, Vertical	Catalogue Number	Cone Size To Fit Flask	Cone Size To Fit Condenser
FAVORIT , MALAYSIA	JSH7/12	19/26	19/26
	JSH7/13	24/29	19/26
	JSH7/53	24/29	24/29

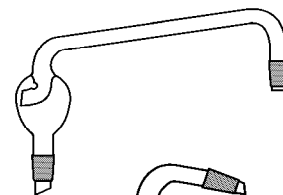

STEAM DISTILLATION HEADS Sloping	Catalogue Number	Cone Size To Fit Flask	Cone Size To Fit Condenser
FAVORIT , MALAYSIA	JSH7/23	24/29	19/26
	JSH7/25	34/35	19/26

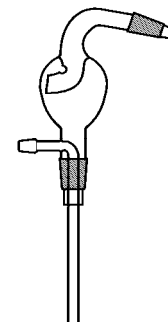

FRACTIONATING, DISTILLATION HEAD with PTFE Stopcock or PTFE Spindle Stopcock	Catalogue Number	Description	Cone Size To Fit Column	Cone Size To Fit Receiver
FAVORIT , MALAYSIA	JSH30/42	Fractional Distillation Head	29/32	19/26

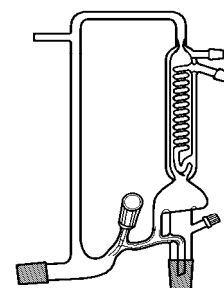

REFLUX DIVIDER	Catalogue Number	Description	Socket or Cup Size	Cone or Ball Size
FAVORIT , MALAYSIA	JFC15/32	SluiceType Head	19/26 & 14/23	24/29 & S13
	JFC15/2	Distillate Adapter with GP Vendura Stopcock	S13	19/26
	2863405	Plastic Spherical Joint Clip	-	-

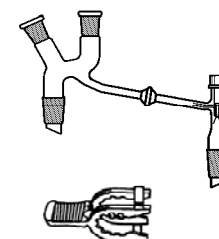

THERMOMETER POCKET	Catalogue Number	Cone Size	Approx. Stem Length mm
FAVORIT , MALAYSIA	JSH4A	14/23	45

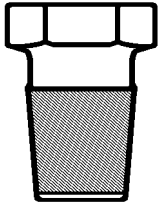

FAVORIT , MALAYSIA

**GLASS STOPPERS**

Hollow Blown

GERMANY

Catalogue Number	Cone Size
JSB07	7/16
JSB10	10/19
JSB12	12/21
JSB14	14/23
JSB19	19/26
JSB24	24/29
JSB29	29/32
JSB34	34/35

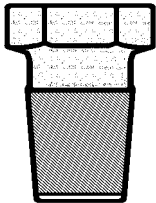
**GLASS STOPPERS****Amber**

Hollow Blown

GERMANY

Catalogue Number	Cone Size
JSB07A	7/16
JSB10A	10/19
JSB12A	12/21
JSB14A	14/23
JSB19A	19/26
JSB24A	24/29
JSB29A	29/32
JSB34A	34/35

PE STOPPER

Catalogue Number	Cone Size
ZPPSB07	7/16
ZPPSB10	10/19
ZPPSB12	12/21
ZPPSB14	14/23
ZPPSB19	19/26
ZPPSB24	24/29
ZPPSB29	29/32
ZPPSB34	34/35

PTFE BLADED STIRRERS

Pivoted

FAVORIT , MALAYSIA

Catalogue Number	Approx. Shaft Dia. mm	Approx. Shaft Length mm	Blade mm	Smallest Neck Passage for Stirrer
BLADE				
JST7/2	(for JST 6/7)		50	19/26 Socket
JST7/3	(for JST 6/7)		75	24/29 Socket
JST7/3L	(for JST 11/5)		75	24/29 Socket
SHAFT				
JST6/7	6	450	-	-
JST11/5	11	750	-	-

STIRRER GUIDES

FAVORIT , MALAYSIA

Catalogue Number	To Fit Shaft mm	Socket Size	Cone Size	Approx. Stem Length mm
JST2/2	6	19/26	19/26	200
JST2/33C	11	24/29	24/29	300
JST2/44C	11	29/32	29/32	300

STIRRER GLANDS

Ground Sleeve

FAVORIT , MALAYSIA

Catalogue Number	To Fit Shaft mm	Thread Size	Cone Size	Description
JST20/2	6	GL 14	19/26	Stirrer Gland
JST20/3	11	GL 25	24/29	Stirrer Gland
JST20/4	11	GL 25	29/32	Stirrer Gland
JST10/2T	6	GL 14	-	Replacement Sleeve to fit JST 20/2
JST10/34T	11	GL 25	-	Replacement Sleeve to fit JST 20/3 or JST 20/4

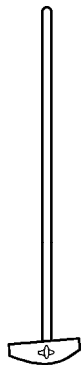
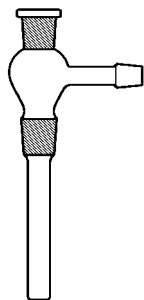

Replacement Sleeve

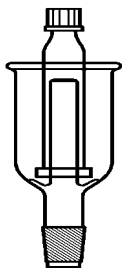

Stirrer Gland

FAVORIT , MALAYSIA

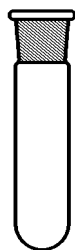

TEST TUBES Non-Graduated	Catalogue Number	Socket Size	Tube Size mm	Approx. Capacity ml
FAVORIT , MALAYSIA	JMF24/0	10/19	14 x 65	2
	JMF24/0/4	10/19	14 x 100	5
	JMF24/12/4	12/21	17 x 100	10
	JMF24/1	14/23	17 x 125	10
	JMF24/1/5	14/23	17 x 125	15
	JMF24/1/6	14/23	17 x 150	16
	JMF24/2	19/26	23 x 100	19
	JMF24/2/6	19/26	23 x 150	31
	JMF24/3	24/29	28 x 150	54
	JMF24/3/8	24/29	28 x 200	75
JMF24/5	34/35	41 x 250	195	

TEST TUBES Non-Graduated with PE Stopper	Catalogue Number	Socket Size	Tube Size mm	Approx. Capacity ml
FAVORIT , MALAYSIA	JTT5/0/P	10/19	14 x 100	5
	JTT10/1/P	14/23	17 x 125	10
	JTT25/2/P	19/26	22 x 125	25
	JTT50/3/P	24/29	28 x 150	50



TEST TUBES Non-Graduated with Glass Stopper	Catalogue Number	Socket Size	Tube Size mm	Approx. Capacity ml
FAVORIT , MALAYSIA	JTT5/0/GL	10/19	14 x 100	5
	JTT10/1/GL	14/23	17 x 125	10
	JTT25/2/GL	19/26	22 x 125	25
	JTT50/3/GL	24/29	28 x 150	50

TEST TUBES Graduated with PE Stopper	Catalogue Number	Socket Size	Tube Size mm	Approx. Capacity ml
FAVORIT , MALAYSIA	JTT5/0G	10/19	14 x 100	5
	JTT10/1G	14/23	17 x 125	10
	JTT25/2G	19/26	22 x 125	25
	JTT50/3G	24/29	28 x 180	50

TEST TUBES Graduated with Glass Stopper	Catalogue Number	Socket Size	Tube Size mm	Approx. Capacity ml
FAVORIT , MALAYSIA	JTT5/0G/GL	10/19	14 x 100	5
	JTT10/1G/GL	14/23	17 x 125	10
	JTT25/2G/GL	19/26	22 x 125	25
	JTT50/3G/GL	24/29	28 x 180	50

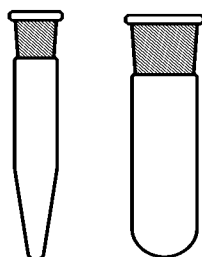

CENTRIFUGE TUBES	Catalogue Number	Socket Size	Tube Size mm	Min. Cap. ml
FAVORIT , MALAYSIA	JBC24/C14T	14/15	17 x 115	10
	JBC24/C24R	24/20	28 x 115	30

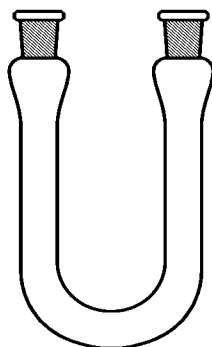

U-SHAPED TUBES	Catalogue Number	Socket Size
FAVORIT , MALAYSIA	JMF21/1	14/23
	JMF21/2	19/26

FAVORIT , MALAYSIA

DIGESTION TUBES with Joint	Catalogue Number	Capacity ml	Tube Size mm	Socket Size
FAVORIT , MALAYSIA	JTJ15/16/1	15	16 x 145	14/23
	JTJ75/26/3	75	26 x 255	24/29
	JTJ100/26/3	100	26 x 300	24/29
	JTJ250/42/6	250	42 x 300	40/38

DIGESTION TUBES Plain	Catalogue Number	Capacity ml	Tube Size mm
FAVORIT , MALAYSIA	JTT75/26	75	26 x 255
	JTT100/26	100	26 x 300
	JTT250/42	250	42 x 300

DIGESTION TUBES Kjeldahl Style	Catalogue Number	Capacity ml	Tube Size mm
Non-Graduated FAVORIT , MALAYSIA	JTK75/26	75	26 x 255
	JTK100/26	100	26 x 300
	JTK250/42	250	42 x 300

DIGESTION TUBES Kjeldahl Style	Catalogue Number	Capacity ml	Tube Size mm	Grad. Mark ml
Graduated FAVORIT , MALAYSIA	JTK75/26G	75	26 x 255	75
	JTK100/26G	100	26 x 300	100
	JTK250/42G	250	42 x 300	250

DIGESTION TUBES Buchi type	Catalogue Number	Capacity ml	Tube Size mm
FAVORIT , MALAYSIA	JTB48/260	250	48 x 260
	JTB48/300	250	48 x 300

AIR/STEAM INLET TUBES Straight with Cone	Catalogue Number	Cone Size	Approx. Stem Length mm
FAVORIT , MALAYSIA	JMF15/0	10/19	100
	JMF15/1	14/23	150
	JMF15/2	19/26	150
	JMF15/3	24/29	150
	JMF15/4	29/32	150

DRYING TUBES Angled	Catalogue Number	Cone Size
FAVORIT , MALAYSIA	JMF23/0	10/19
	JMF23/1	14/23
	JMF23/2	19/26
	JMF23/3	24/29
	JMF23/4	29/32

DRYING TUBE Straight	Catalogue Number	Cone Size
FAVORIT , MALAYSIA	JMU23/0	10/19

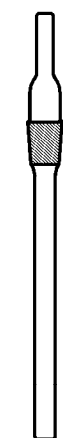
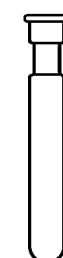
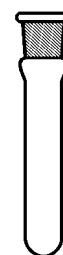

FAVORIT , MALAYSIA

EXTRACTION APPARATUS

Catalogue Number	Description
J25RASX	COMPLETE ASSEMBLY. Cap. : 20 ml
	Components :
JEX5/32	Soxhlet Extractor 20 ml
JFR50/2S	Round Bottom Flask 50 ml
JCX7/03	Allihn Condenser
J40RASX	COMPLETE ASSEMBLY. Cap. : 40 ml
	Components :
JEX5/43	Soxhlet Extractor 40 ml
JFR100/3S	Round Bottom Flask 100 ml
JCX7/04	Allihn Condenser
J60RASX	COMPLETE ASSEMBLY. Cap. : 60 ml
	Components :
JEX5/53	Soxhlet Extractor 60 ml
JFR150/3S	Round Bottom Flask 150 ml
JCX7/05	Allihn Condenser
J100RASX	COMPLETE ASSEMBLY. Cap. : 100 ml
	Components :
JEX5/63	Soxhlet Extractor 100 ml
JFR250/3S	Round Bottom Flask 250 ml
JCX7/06	Allihn Condenser
J200RASX	COMPLETE ASSEMBLY. Cap. : 200 ml
	Components :
JEX5/83	Soxhlet Extractor 200 ml
JFR500/3S	Round Bottom Flask 500 ml
JCX7/08	Allihn Condenser
J600RDSX	COMPLETE ASSEMBLY. Cap. : 600 ml
	Components :
JEX5/75/5	Soxhlet Extractor 600 ml
JDA5/75	Flange Lid
JJC75F	Metal Joint Clip 75mm
JFR2L/5S	Round Bottom Flask 2000 ml
JCX5/25	Double Surface Condenser 60x200 (ID)
J2LRCSX	COMPLETE ASSEMBLY. Cap. : 2 L
	Components :
JEX5/100/5	Soxhlet Extractor 2000 ml
JDA5/100	Flange Lid
JJC100F	Metal Joint Clip 100mm
JFR5L/5S	Round Bottom Flask 5000 ml
JC13/55	Multi-coil Condenser

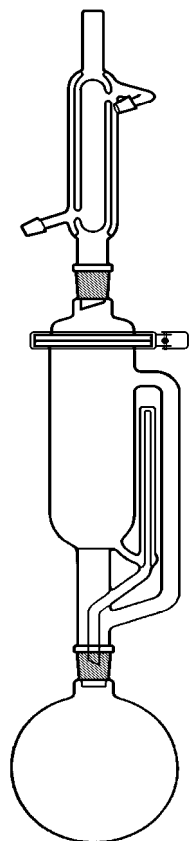
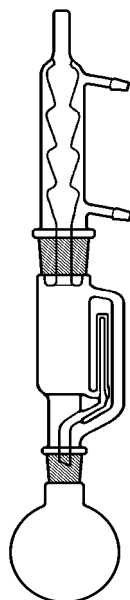

FAVORIT , MALAYSIA

KJELDAHL DISTILLATION ASSEMBLY

Nitrogen Determination

Catalogue Number	Description	Socket Size	Cone Size
J280 MC	COMPLETE ASSEMBLY	-	-
Components :			
JC 1/12	Condenser	19/26	19/26
JRA 1/22	Delivery Adapter	19/26	-
JD 62/50PT	Dropping Funnel, 50 ml		19/26
JMA 1/3	Multiple Adapter	19/26	24/29
JFK 500/3L	Kjeldahl Flask, 500 ml	24/29	-
JSH 7/12	Splash Head	19/26	19/26
2863364	2 X Plastic Conical Joint Clips 19/26	-	-

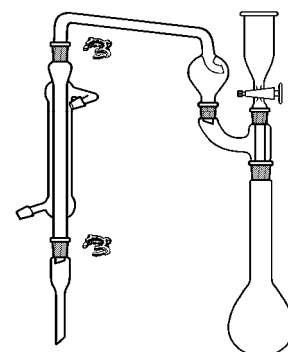

HOSKINS MICRO-KJELDAHL DISTILLATION APPARATUS

Catalogue Number	Description	Socket Size	Cone Size
JHMK80	COMPLETE ASSEMBLY	-	-
Components :			
JIV	Inner Vessel, Capacity 80 ml	-	50/42
JOV	Outer Vessel (Jacket)	50/42	-
JHC	Hoskins Condenser	-	-
JPS	Peg Stopper	-	10/19

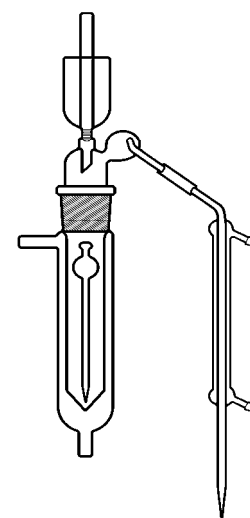

SEMI-MICRO KJELDAHL APPARATUS

Catalogue Number	Description	Socket/Cup Size	Cone/Ball Size
J21/50MC	COMPLETE ASSEMBLY (50 ml CAPACITY)	-	-
J21/100MC	COMPLETE ASSEMBLY (100 ml CAPACITY)	-	-
Components :			
JMC22/50	Kjeldahl Flask, 50 ml	19/26	
JMC22/100	Kjeldahl Flask, 100 ml	19/26	-
	Condenser	S19	-
	Distillation Head	10/19	19/26 & S19
	Cone	-	10/19
2863406	Plastic Spherical Joint Clip KS 19	-	-
2863364	Plastic Conical Joint Clips KC 19	-	-

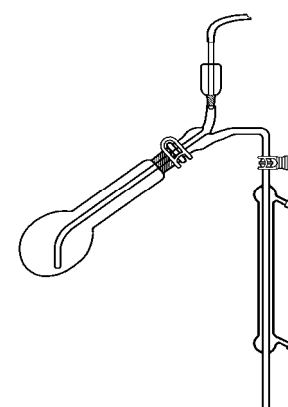

FAVORIT , MALAYSIA

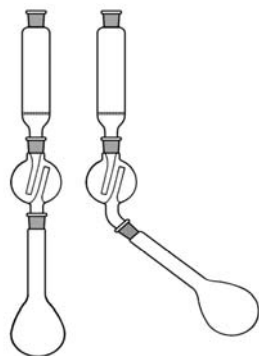

ABSORPTION TRAPS

Nitrogen Determination

Catalogue Number	Description	Capacity ml	Socket Size	Cone Size
JMC12/33	Lower Chamber, Straight	250	24/29	24/29
JMC12/33B	Lower Chamber. Angled 45°	250	24/29	24/29
JMC13/33	Upper Chamber	-	24/29	24/29

MARKHAM DISTILLATION UNIT

Nitrogen Determination

Catalogue Number	Description	Spherical Joint Size
J46MC	COMPLETE ASSEMBLY	-
Components :		
JMC46	Markham Still Body, 25 ml Capacity	S19
JMC1/F19	Condenser	S19
2863406	Plastic Spherical Joint Clip KS19	-
JPS	Peg Stopper	-

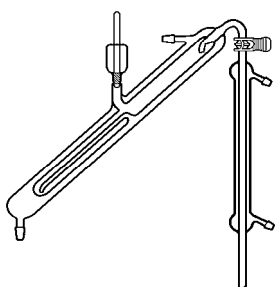

TILT MEASURE (AUTOMATIC PIPETTE)

Catalogue Number	Capacity ml
------------------	-------------

TILT MEASURE

JTM3/5	5
JTM3/10	10
JTM3/20	20
JTM3/25	25
JTM3/50	50

TILT MEASURE c/w 500 ML BOTTLE RESERVOIR

JTM3/5RB	5
JTM3/10RB	10
JTM3/20RB	20
JTM3/25RB	25
JTM3/50RB	50

TILT MEASURE with CONE 24/29

JTM3/5S	5
JTM3/10S	10
JTM3/20S	20
JTM3/25S	25
JTM3/50S	50

TILT MEASURE c/w 500 ML ERLLENMEYER FLASK RESERVOIR

JTM3/5RF	5
JTM3/10RF	10
JTM3/20RF	20
JTM3/25RF	25
JTM3/50RF	50

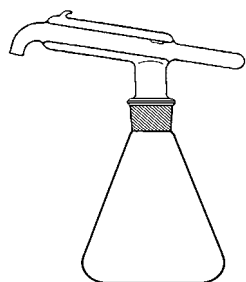
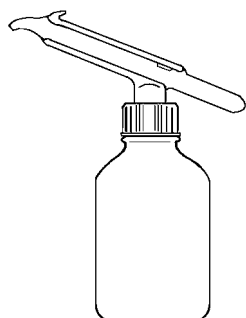

FAVORIT , MALAYSIA

CHROMATOGRAPHY APPARATUS

with 10mm x 100mm Column

Catalogue Number	Description	Socket Size	Cone Size
J1CR	COMPLETE ASSEMBLY	-	-
	Components :		
JMF10/1B	Cone Adapter	-	14/23
JD2/11/PT	Reservoir, 50 ml	14/23	14/23
JCR12/10/PT	Column with Sinter Porosity 0 and Tap	14/23	19/26
JCR41/42	Tamping Rod	-	-
JFB100/2	Flask, 100 ml	19/26	-
2863363	2 X Plastic Conical Joint Clips 14/23	-	-

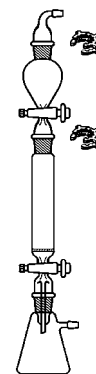

CHROMATOGRAPHY APPARATUS

with 18mm x 200mm Column

Catalogue Number	Description	Socket Size	Cone Size
J2CR	COMPLETE ASSEMBLY	-	-
	Components :		
JD3/32/PT	Reservoir, 250 ml	-	19/26
JDA23	Reduction Adapter	19/26	24/29
JCR32/20	Column with Sinter Porosity 0	24/29	19/26
JCR43/53	Tamping Rod	-	-
JCR3T/23/PT	Tap Adapter	19/26	24/29
JFB250/3	Flask, 250 ml	24/29	-
2863364	Plastic Conical Joint Clip 19/26	-	-
2863365	Plastic Conical Joint Clip 24/29	-	-

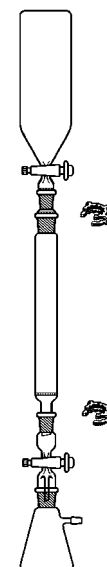

ARSENIC DETERMINATION APPARATUS

also suitable for Antimony Estimation

Catalogue Number	Description	Nom. Cap. ml	Socket Size	Cone Size
J1AD/1	COMPLETE ASSEMBLY	-	-	-
	Components :			
JAD3	Absorption Tube	-	-	24/29
JFE100/3	Erlenmeyer Flask	100	24/29	-

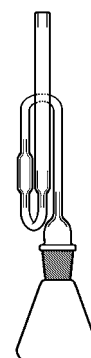

WATER ESTIMATION APPARATUS (DEAN & STARK PATTERN)

Light Entrainers

Catalogue Number	Description	Graduation ml	Socket Size	Cone Size
JWE6/23/2	Receiver 2 ml	0.05	19/26	24/29
JWE6/23/10TL	Receiver 10 ml with Stopcock	0.1	19/26	24/29

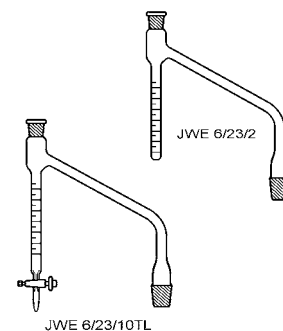

Plasticware

NERBE PLUS, GERMANY

MICRO CENTRIFUGE TUBES with Lid, PP	Catalogue	
	Number	Capacity
	NP040441	0.5 ml
NERBE PLUS , GERMANY	NP040111	1.5 ml

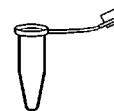

SQUARE CUVETTES PS, Optical Path Length 10 mm	Catalogue		
	Number	Capacity	Dimension
	NP060101	1.5 ml	12 x 45 mm
NERBE PLUS , GERMANY	NP060111	4 ml	12 x 45 mm

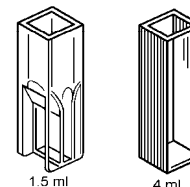

PIPETTE TIPS	Catalogue		
	Number	Capacity	Colour
NERBE PLUS , GERMANY	NP070103	5 - 100 ul	Yellow
	NP070113	101 - 1000 ul	Blue
	NP070116	0.5 - 10 ul	Crystal
	NP070117	0.5 - 10 ul	Crystal
	NP070178	1 - 200 ul	Yellow
	NP070188	101 - 1000 ul	Blue
TREFFLAB , SWITZERLAND	96.8755.9.01	5 ml	Clear
HIRSCHMANN , GERMANY	96.10720.9.01	10 ml	Clear
	949 01 24	1 - 5 ml	Clear

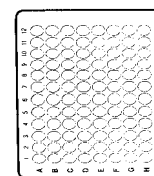
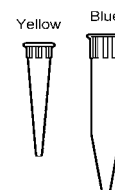

MICRO TEST PLATES PS	Catalogue	
	Number	Description
	NP100101	U Shape, 96 Cavities
NERBE PLUS , GERMANY	NP100111	V Shape, 96 Cavities
	NP100131	LID for Micro Test Plate

LIQUIPETTES (Pasteur Pipettes) PE, Graduated	Catalogue	
	Number	Capacity
	NP120103	1 ml
NERBE PLUS , GERMANY	NP120113	3 ml

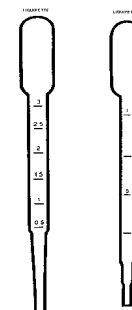

FAVORIT, MALAYSIA

DISPOSABLE PETRI DISH	Catalogue	
	Number	Capacity
	P9222-0001	90 x 15mm



FAVORIT, MALAYSIA

Plasticware

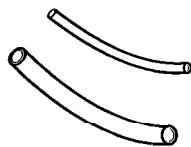

SILICONE TUBINGS	Catalogue Number	I.D. x O.D. mm
Autoclavable	3100305	3 x 5
able to withstand extreme temp. from - 60 °C to 280 °C.	3100408	4 x 8
	3100507	5 x 7
	3100508	5 x 8
	3100609	6 x 9
	3100710	7 x 10
	3100812	8 x 12
	3101014	10 x 14
	3101216	12 x 16

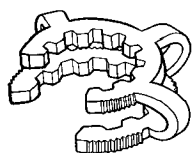

KECK CONICAL JOINT CLIPS	Catalogue Number	Description	Colour
Plastic	2863361	For 10/19 socket & cone joints	Mint
for Socket & Cone	2863362	For 12/21 socket & cone joints	Violet
Glass Joints	2863363	For 14/23 socket & cone joints	Yellow
	2863364	For 19/26 socket & cone joints	Blue
DURAN , GERMANY	2863365	For 24/29 socket & cone joints	Green
	2863366	For 29/32 socket & cone joints	Red
	2863367	For 34/35 socket & cone joints	Orange
	2863368	For 40/38 socket & cone joints	Ochre
	2863369	For 45/40 socket & cone joints	Brown



GROUND JOINT SLEEVES PTFE	Catalogue Number	Description
for Sealing	BB930-04	For 14/23 socket & cone joints
Conical Glass Joints	BB930-05	For 19/26 socket & cone joints
	BB930-06	For 24/29 socket & cone joints
BOLA BOHLENDER	BB930-07	For 29/32 socket & cone joints
GERMANY	BB930-08	For 34/35 socket & cone joints
	BB930-09	For 40/38 socket & cone joints
	BB930-11	For 50/42 socket & cone joints

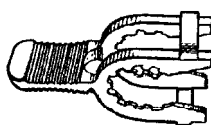

KECK SPHERICAL JOINT CLIPS	Catalogue Number	Description	Colour
Plastic	2863405	For S13 ball & cup joints	Violet
for Ball & Cup	2863406	For S19 ball & cup joints	Dark Blue
Glass Joints	2863408	For S29 ball & cup joints	Dark Red
DURAN , GERMANY	2863409	For S35 ball & cup joints	Light Orange



R/B FLASK SUPPORT, PP	Catalogue Number	Diameter mm	Height mm
for Round Bottom Flasks of 10 to 10,000 ml capacity	VL80271	170	50

Plasticware

PIPETTE STAND	Catalogue Number	Description
Plastic	P902194	for 94 Pipettes Rotary rack, consisting of a base plate and vertical rod accomodating a rotary unit composed of two end-plates and a spacer-tube.



TEST TUBE RACKS	Catalogue Number	Hole size mm	No. of Holes	Hole Format
Plastic (PP)				
KARTELL	KAR564	13	90	6 x 15
	KAR565	16	60	5 x 12
	KAR566	20	40	4 x 10
	KAR567	25	40	4 x 10
	KAR568	30	24	3 x 8

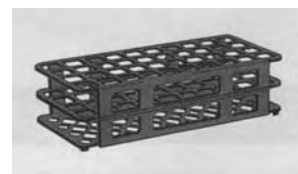

MEASURING CYLINDERS	Catalogue Number	Capacity ml
Translucent		
Hexagonal Base	7500160	10
DIN 12681 / ISO 6706	7500170	25
	7500175	50
HIRSCHMANN , GERMANY	7500180	100
	7500186	250
	7500190	500
	7500193	1000
	7500194	2000



MEASURING JUGS	Catalogue Number	Capacity ml
Plastic (PP)		
with embossed blue graduation	7600280	100
	7600286	250
	7600290	500
HIRSCHMANN , GERMANY	7600293	1000
	7600294	2000
	7600296	3000
	7600297	5000



BEAKERS	Catalogue Number	Capacity ml
Plastic (PP)		
with blue graduation	7600160	10
DIN 12331 / ISO 7056	7600170	25
	7600175	50
HIRSCHMANN , GERMANY	7600180	100
	7600186	250
	7600190	500
	7600191	600
	7600193	1000
	7600194	2000



PI-PUMP	Catalogue Number	Suitable for Pipettes up to ml
with flexible pipette holding socket & special release valve	P120	(Blue) 2
	P121	(Green) 10
FAVORIT / MALAYSIA	P122	(Red) 25



Plasticware

VOLUMETRIC FLASKS	Catalogue Number	Volume ml
Plastic (PP)	755 01 70	25
with NS poly-stoppers	755 01 75	50
DIN 12664	755 01 81	100
HIRSCHMANN , GERMANY	755 01 86	250
	755 01 90	500
	755 01 93	1000



FUNNELS	Catalogue Number	Diameter mm
Plastic	MX2PFNL075	70
	MX2PFNL090	90

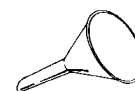

ASPIRATOR BOTTLES	Catalogue Number	Capacity L
Plastic	MX2PAB5L	5
POLYSOL	MX2PAB10L	10
	MX2PAB25L	25
	MX2PAB60L	60

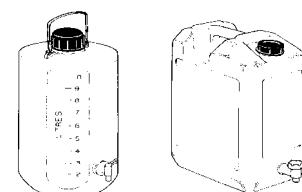

WASH BOTTLES	Catalogue Number	Capacity ml
Plastic	MX2PWB250	250
S. MURRAY , U.K.	MX2PWB500	500

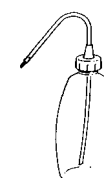

MAGNETIC STIRRING BARS	Catalogue Number	Description
	P823415	4 x 15 mm
	P823620	6 x 20 mm
	P823625	6 x 25 mm
	P823630	6 x 30 mm
	P823635	6 x 35 mm
	P823840	8 x 40 mm
	P823845	8 x 45 mm
	P823851	8 x 50 mm
FAVORIT , MALAYSIA	P823960	9 x 60 mm
	P823970	9 x 70 mm

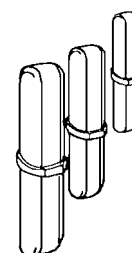

MAGNETIC STIRRING RETRIEVER	P823350	350mm, PTFE Coated
FAVORIT / MALAYSIA		

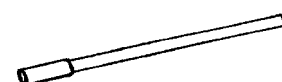

SAFETY PIPETTE FILLER	Catalogue Number	Description
D & N , GERMANY	DN4700001	Standard Model
FAVORIT , MALAYSIA	P4700001	Standard Model

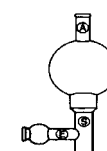

BLOWBALL	Catalogue Number	Suitable for Pipettes up to ml
for Auto-Burettes	DN4200005	
D & N , GERMANY		



FILTRES FIORONI, FRANCE



Qualitative Filter Papers Grade 601

Equivalent to Whatman N°1

Catalogue No.	Diameter(mm)	Pore Size	UOM	Brand
F-0601A00000	40	5 - 13µm	Box of 100	FILTRES FIORONI/ FRANCE
F-0601A00001	42.5	5 - 13µm	Box of 100	
F-0601A00002	47	5 - 13µm	Box of 100	
F-0601A00003	55	5 - 13µm	Box of 100	
F-0601A00004	70	5 - 13µm	Box of 100	
F-0601A00005	85	5 - 13µm	Box of 100	
F-0601A00006	90	5 - 13µm	Box of 100	
F-0601A00007	110	5 - 13µm	Box of 100	
F-0601A00008	125	5 - 13µm	Box of 100	
F-0601A00009	130	5 - 13µm	Box of 100	
F-0601A00010	150	5 - 13µm	Box of 100	
F-0601A00011	185	5 - 13µm	Box of 100	
F-0601A00012	190	5 - 13µm	Box of 100	
F-0601A00013	210	5 - 13µm	Box of 100	
F-0601A00014	240	5 - 13µm	Box of 100	
F-0601A00015	270	5 - 13µm	Box of 100	
F-0601A00016	320	5 - 13µm	Box of 100	
F-0601A00017	385	5 - 13µm	Box of 100	
F-0601A00018	400	5 - 13µm	Box of 100	
F-0601A00019	250	5 - 13µm	Box of 100	
F-0601A00020	500	5 - 13µm	Box of 100	
F-0601A00021	75	5 - 13µm	Box of 100	
F-0601A00023	45	5 - 13µm	Box of 100	
F-0601A00024	180	5 - 13µm	Box of 100	
F-0601A00025	100	5 - 13µm	Box of 100	
F-0601A00026	120	5 - 13µm	Box of 100	
F-0601A00027	50	5 - 13µm	Box of 100	
F-0601A00028	80	5 - 13µm	Box of 100	
F-0601A00029	300	5 - 13µm	Box of 100	
F-0601A00030	330	5 - 13µm	Box of 100	

Qualitative Filter Papers Grade 113

Equivalent to Whatman N°2

Catalogue No.	Diameter(mm)	Pore Size	UOM	Brand
F-0113A00000	47	5 - 8µm	Box of 100	FILTRES FIORONI/ FRANCE
F-0113A00001	42.5	5 - 8µm	Box of 100	
F-0113A00002	45	5 - 8µm	Box of 100	
F-0113A00003	55	5 - 8µm	Box of 100	
F-0113A00004	70	5 - 8µm	Box of 100	
F-0113A00005	90	5 - 8µm	Box of 100	
F-0113A00006	110	5 - 8µm	Box of 100	
F-0113A00007	125	5 - 8µm	Box of 100	
F-0113A00008	135	5 - 8µm	Box of 100	
F-0113A00009	150	5 - 8µm	Box of 100	
F-0113A00010	185	5 - 8µm	Box of 100	
F-0113A00011	210	5 - 8µm	Box of 100	
F-0113A00012	240	5 - 8µm	Box of 100	
F-0113A00013	190	5 - 8µm	Box of 100	
F-0113A00014	320	5 - 8µm	Box of 100	
F-0113A00015	120	5 - 8µm	Box of 100	
F-0113A00017	400	5 - 8µm	Box of 100	
F-0113A00018	200	5 - 8µm	Box of 100	
F-0113A00022	270	5 - 8µm	Box of 100	
F-0113A00025	500	5 - 8µm	Box of 100	
F-0113A00026	385	5 - 8µm	Box of 100	

Qualitative Filter Papers Grade 111

Equivalent to Whatman N°4

Catalogue No.	Diameter(mm)	Pore Size	UOM	Brand
F-0111A00002	45	12 - 15µm	Box of 100	FILTRES FIORONI/ FRANCE
F-0111A00003	55	12 - 15µm	Box of 100	
F-0111A00004	70	12 - 15µm	Box of 100	
F-0111A00005	90	12 - 15µm	Box of 100	
F-0111A00006	110	12 - 15µm	Box of 100	
F-0111A00007	125	12 - 15µm	Box of 100	
F-0111A00009	150	12 - 15µm	Box of 100	
F-0111A00010	185	12 - 15µm	Box of 100	
F-0111A00011	210	12 - 15µm	Box of 100	
F-0111A00012	240	12 - 15µm	Box of 100	
F-0111A00014	320	12 - 15µm	Box of 100	
F-0111A00022	270	12 - 15µm	Box of 100	
F-0111A00026	385	12 - 15µm	Box of 100	

Quantitative Filter Papers Grade 11

Equivalent to Whatman N°41

Catalogue No.	Diameter(mm)	Pore Size	UOM	Brand
F-0011A00001	42.5	12 - 15µm	Box of 100	FILTRES FIORONI/ FRANCE
F-0011A00002	45	12 - 15µm	Box of 100	
F-0011A00003	55	12 - 15µm	Box of 100	
F-0011A00004	70	12 - 15µm	Box of 100	
F-0011A00005	90	12 - 15µm	Box of 100	
F-0011A00006	110	12 - 15µm	Box of 100	
F-0011A00007	125	12 - 15µm	Box of 100	
F-0011A00008	135	12 - 15µm	Box of 100	
F-0011A00009	150	12 - 15µm	Box of 100	
F-0011A00010	185	12 - 15µm	Box of 100	
F-0011A00011	210	12 - 15µm	Box of 100	
F-0011A00012	240	12 - 15µm	Box of 100	
F-0011A00013	155	12 - 15µm	Box of 100	
F-0011A00014	250	12 - 15µm	Box of 100	
F-0011A00015	158.5	12 - 15µm	Box of 100	
F-0011A00018	270	12 - 15µm	Box of 100	
F-0011A00020	50	12 - 15µm	Box of 100	
F-0011A00023	320	12 - 15µm	Box of 100	
F-0011A00024	120	12 - 15µm	Box of 100	
F-0011A00027	15	12 - 15µm	Box of 100	
F-0011A00029	21	12 - 15µm	Box of 100	
F-0011A00031	40.5	12 - 15µm	Box of 100	

Quantitative Filter Papers Grade 13

Equivalent to Whatman N°40

Catalogue No.	Diameter(mm)	Pore Size	UOM	Brand
F-0013A00001	42.5	5 - 8µm	Box of 100	FILTRES FIORONI/ FRANCE
F-0013A00002	45	5 - 8µm	Box of 100	
F-0013A00003	55	5 - 8µm	Box of 100	
F-0013A00004	70	5 - 8µm	Box of 100	
F-0013A00005	90	5 - 8µm	Box of 100	
F-0013A00006	110	5 - 8µm	Box of 100	
F-0013A00007	125	5 - 8µm	Box of 100	
F-0013A00008	135	5 - 8µm	Box of 100	
F-0013A00009	150	5 - 8µm	Box of 100	
F-0013A00010	185	5 - 8µm	Box of 100	
F-0013A00011	210	5 - 8µm	Box of 100	
F-0013A00012	240	5 - 8µm	Box of 100	
F-0013A00013	140	5 - 8µm	Box of 100	
F-0013A00015	158.5	5 - 8µm	Box of 100	
F-0013A00016	100	5 - 8µm	Box of 100	

F-0013A00019	60	5 -8µm	Box of 100	FILTRES FIORONI/ FRANCE
F-0013A00020	50	5 -8µm	Box of 100	
F-0013A00021	32	5 -8µm	Box of 100	
F-0013A00023	320	5 -8µm	Box of 100	
F-0013A00027	15	5 -8µm	Box of 100	

Quantitative Filter Papers Grade 15

Equivalent to Whatman N°42

Catalogue No.	Diameter(mm)	Pore Size	UOM	Brand
F-0015A00001	42.5	2 -3µm	Box of 100	FILTRES FIORONI/ FRANCE
F-0015A00002	45	2 -3µm	Box of 100	
F-0015A00003	55	2 -3µm	Box of 100	
F-0015A00004	70	2 -3µm	Box of 100	
F-0015A00005	90	2 -3µm	Box of 100	
F-0015A00006	110	2 -3µm	Box of 100	
F-0015A00007	125	2 -3µm	Box of 100	
F-0015A00008	135	2 -3µm	Box of 100	
F-0015A00009	150	2 -3µm	Box of 100	
F-0015A00010	185	2 -3µm	Box of 100	
F-0015A00011	210	2 -3µm	Box of 100	
F-0015A00012	240	2 -3µm	Box of 100	
F-0015A00014	250	2 -3µm	Box of 100	
F-0015A00020	50	2 -3µm	Box of 100	
F-0015A00023	320	2 -3µm	Box of 100	
F-0015A00024	120	2 -3µm	Box of 100	
F-0015A00025	130	2 -3µm	Box of 100	
F-0015A00027	15	2 -3µm	Box of 100	
F-0015A00028	24	2 -3µm	Box of 100	
F-0015A00030	180	2 -3µm	Box of 100	

Micro-Glass Fibre Filters Grade 259

Equivalent to Whatman GF/A

Catalogue No.	Diameter(mm)	Pore Size	UOM	Brand
F-0259A00001	25	1.6µm	Box of 100	FILTRES FIORONI/ FRANCE
F-0259A00002	38	1.6µm	Box of 100	
F-0259A00003	42.5	1.6µm	Box of 100	
F-0259A00004	47	1.6µm	Box of 100	
F-0259A00005	55	1.6µm	Box of 100	
F-0259A00006	60	1.6µm	Box of 100	
F-0259A00007	70	1.6µm	Box of 100	
F-0259A00008	90	1.6µm	Box of 100	
F-0259A00009	110	1.6µm	Box of 100	
F-0259A00010	118	1.6µm	Box of 100	
F-0259A00011	125	1.6µm	Box of 100	
F-0259A00012	150	1.6µm	Box of 100	
F-0259A00013	185	1.6µm	Box of 100	
F-0259A00014	240	1.6µm	Box of 100	
F-0259A00016	37	1.6µm	Box of 100	
F-0259A00017	85	1.6µm	Box of 100	
F-0259A00018	100	1.6µm	Box of 100	
F-0259A00021	142	1.6µm	Box of 100	
F-0259A00025	80	1.6µm	Box of 100	
F-0259A00028	88	1.6µm	Box of 100	

Micro-Glass Fibre Filters Grade 260

Equivalent to Whatman GF/B

Catalogue No.	Diameter(mm)	Pore Size	UOM	Brand
F-0260A00001	25	1.0µm	Box of 50	FILTRES FIORONI/ FRANCE
F-0260A00003	42.5	1.0µm	Box of 50	
F-0260A00004	47	1.0µm	Box of 50	
F-0260A00005	55	1.0µm	Box of 50	
F-0260A00006	60	1.0µm	Box of 50	
F-0260A00007	70	1.0µm	Box of 50	
F-0260A00008	90	1.0µm	Box of 50	
F-0260A00009	110	1.0µm	Box of 25	
F-0260A00011	125	1.0µm	Box of 25	
F-0260A00012	150	1.0µm	Box of 25	
F-0260A00016	185	1.0µm	Box of 25	
F-0260A00019	100	1.0µm	Box of 25	
F-0260A00020	293	1.0µm	Box of 25	

Micro-Glass Fibre Filters Grade 261

Equivalent to Whatman GF/C

Catalogue No.	Diameter(mm)	Pore Size	UOM	Brand
F-0261A00001	25	1.2µm	Box of 100	FILTRES FIORONI/ FRANCE
F-0261A00002	37	1.2µm	Box of 100	
F-0261A00003	42.5	1.2µm	Box of 100	
F-0261A00004	47	1.2µm	Box of 100	
F-0261A00005	55	1.2µm	Box of 100	
F-0261A00006	60	1.2µm	Box of 100	
F-0261A00007	70	1.2µm	Box of 100	
F-0261A00008	90	1.2µm	Box of 100	
F-0261A00009	110	1.2µm	Box of 100	
F-0261A00010	100	1.2µm	Box of 100	
F-0261A00011	125	1.2µm	Box of 100	
F-0261A00012	150	1.2µm	Box of 100	
F-0261A00013	28	1.2µm	Box of 100	
F-0261A00014	185	1.2µm	Box of 50	
F-0261A00017	85	1.2µm	Box of 100	
F-0261A00018	140	1.2µm	Box of 100	
F-0261A00021	21	1.2µm	Box of 100	
F-0261A00022	24	1.2µm	Box of 100	

Micro-Glass Fibre Filters Grade 262

Equivalent to Whatman GF/D

Catalogue No.	Diameter(mm)	Pore Size	UOM	Brand
F-0262A00001	25	2.7µm	Box of 50	FILTRES FIORONI/ FRANCE
F-0262A00002	37	2.7µm	Box of 50	
F-0262A00004	47	2.7µm	Box of 50	
F-0262A00005	55	2.7µm	Box of 50	
F-0262A00007	70	2.7µm	Box of 50	
F-0262A00008	90	2.7µm	Box of 50	
F-0262A00009	110	2.7µm	Box of 25	
F-0262A00011	125	2.7µm	Box of 25	
F-0262A00012	150	2.7µm	Box of 25	
F-0262A00015	185	2.7µm	Box of 25	

MEMBRANE SOLUTION,CHINA



Nylon Membrane Filter

Catalogue No.	Pore Size	Diameter(mm)	Packaging (Box of)	Brand
F-MFNY013022	0.22µm	13	400	MEMBRANE SOLUTION/CHINA
F-MFNY025022	0.22µm	25	200	
F-MFNY047022	0.22µm	47	200	
F-MFNY013045	0.45µm	13	400	
F-MFNY025045	0.45µm	25	200	
F-MFNY047045	0.45µm	47	200	

MCE Membrane Filter

Catalogue No.	Pore Size	Diameter(mm)	Packaging (Box of)	Brand
F-MFMCE013022	0.22µm	13	400	MEMBRANE SOLUTION/CHINA
F-MFMCE025022	0.22µm	25	200	
F-MFMCE047022	0.22µm	47	200	
F-MFMCE013045	0.45µm	13	400	
F-MFMCE025045	0.45µm	25	200	
F-MFMCE047045	0.45µm	47	200	

MCE Gridded Membrane Filter

Individually package, White, Sterile, With Pad

Catalogue No.	Pore Size	Diameter(mm)	Packaging (Box of)	Brand
F-MFMCE047045GWSP	0.45µm	47	100	MEMBRANE SOLUTION/CHINA

Cellulose Acetate Syringe Filter , Sterile

Catalogue No.	Pore Size	Housing Diameter(mm)	Packaging (Box of)	Brand
F-SFCA013022S	0.22µm	13	100	MEMBRANE SOLUTION/CHINA
F-SFCA013045S	0.45µm	13	100	
F-SFCA025022S	0.22µm	25	100	
F-SFCA025045S	0.45µm	25	100	
F-SFCA030022S	0.22µm	30	100	
F-SFCA030045S	0.45µm	30	100	

Nylon66 Syringe Filter (Polyamide-66) Sterile

Catalogue No.	Pore Size	Housing Diameter(mm)	Packaging (Box of)	Brand
F-SFNY013022S	0.22µm	13	100	MEMBRANE SOLUTION/CHINA
F-SFNY013045S	0.45µm	13	100	
F-SFNY025022S	0.22µm	25	100	
F-SFNY025045S	0.45µm	25	100	
F-SFNY030022S	0.22µm	30	100	
F-SFNY030045S	0.45µm	30	100	

Favorit Extraction Thimble

Catalogue No.	Diameter(I.D. x Height)	UOM	Brand
F-CT19090	19 x 90mm	Box of 25	FAVORIT EXTRACTION THIMBLE/ MALAYSIA
F-CT22060	22 x 60mm	Box of 25	
F-CT22080	22 x 80mm	Box of 25	
F-CT25065	25 x 65mm	Box of 25	
F-CT25080	25 x 80mm	Box of 25	
F-CT25100	25 x 100mm	Box of 25	
F-CT28100	28 x 100mm	Box of 25	
F-CT30080	30 x 80mm	Box of 25	
F-CT30100	30 x 100mm	Box of 25	
F-CT33080	33 x 80mm	Box of 25	
F-CT33100	33 x 100mm	Box of 25	
F-CT43123	43 x 123mm	Box of 25	

Electric Cast Aluminum Sterilizer

Catalogue No.	Model	Description	UOM	Brand
AA25X	25X-240V	Electric Cast Aluminum Sterilizer Inner Container Capacity 14.5 qt. / 13.7 liter Gross Capacity: 25 qt. / 24 liter 1050 watts/4.38 amps	unit	All American/ USA
AA50X	50X-240V	Electric Cast Aluminum Sterilizer 50X-240 Inner Container Capacity 14.5 qt. / 13.7 liter Gross Capacity: 25 qt. / 24 liter 1650 watts/6.88 amps	unit	All American/ USA
AA75X	75X-240	Electric Cast Aluminum Sterilizer 75X-240 Inner Container Capacity 27.3 qt. / 25.8 liter Gross Capacity: 41 qt. / 39 liter 1650 Watts/6.88 amps	unit	All American/ USA

BRAND, GERMANY



Titrette (Replacement Of Digital Burette III)

Catalogue No.	Description
BD4760151	Titrette 25ml, With Safety Prime Recirculating Valve
BD4760161	Titrette 50ml, With Safety Prime Recirculating Valve

Dispensette III, Analog-Adjustable

BD4700130	0.5 - 5ml, Without Safety Prime Recirculation Valve
BD4700140	1 - 10ml, Without Safety Prime Recirculation Valve
BD4700150	2.5 - 25ml, Without Safety Prime Recirculation Valve
BD4700160	5 - 50ml, Without Safety Prime Recirculation Valve
BD4700170	10 - 100ml, Without Safety Prime Recirculation Valve
BD4700131	0.5 - 5ml, With Safety Prime Recirculating Valve
BD4700141	1 - 10ml, With Safety Prime Recirculating Valve
BD4700151	2.5 - 25ml, With Safety Prime Recirculating Valve
BD4700161	5 - 50ml, With Safety Prime Recirculating Valve
BD4700171	10 - 100ml, With Safety Prime Recirculating Valve

Dispensette III, Easy Calibration

BD4700320	0.2 - 2ml, Without Safety Prime Recirculation Valve
BD4700330	0.5 - 5ml, Without Safety Prime Recirculation Valve
BD4700340	1 - 10ml, Without Safety Prime Recirculation Valve
BD4700350	2.5 - 25ml, Without Safety Prime Recirculation Valve
BD4700360	5 - 50ml, Without Safety Prime Recirculation Valve
BD4700341	1 - 10ml, With Safety Prime Recirculation Valve
BD4700351	2.5 - 25ml, With Safety Prime Recirculation Valve
BD4700361	5 - 50ml, With Safety Prime Recirculation Valve

Dispensette Organic, Analog-Adjustable

BD4730130	0.5 - 5ml, Without Safety Prime Recirculation Valve
BD4730140	1 - 10ml, Without Safety Prime Recirculation Valve
BD4730150	2.5 - 25ml, Without Safety Prime Recirculation Valve
BD4730160	5 - 50ml, Without Safety Prime Recirculation Valve
BD4730170	10 - 100ml, Without Safety Prime Recirculation Valve
BD4730131	0.5 - 5ml, With Safety Prime Recirculation Valve
BD4730141	1 - 10ml, With Safety Prime Recirculation Valve
BD4730151	2.5 - 25ml, With Safety Prime Recirculation Valve
BD4730161	5 - 50ml, With Safety Prime Recirculation Valve

Dispensette Organic, Easy Calibration

BD4730330	0.5 - 5ml, Without Safety Prime Recirculation Valve
BD4730340	1 - 10ml, Without Safety Prime Recirculation Valve
BD4730350	2.5 - 25ml, Without Safety Prime Recirculation Valve
BD4730360	5 - 50ml, Without Safety Prime Recirculation Valve
BD4730361	5 - 50ml, With Safety Prime Recirculation Valve

Dispensette HF

BD4700041	1 - 10ml, With Safety Prime Recirculation Valve
-----------	---

Macro Pipette Controller

BD26100	Macro Pipette Controller 0.1 - 100ml
BD706080	Safety Prime Recirculation Valve for Dispensette III 1 - 100ml
BD706090	Safety Prime Recirculation Valve for Dispensette Organic

Catalogue No.	Description	UOM	Brand
CDR-225001Z02	PalmOil Tester Basic Version , determination of Acidity (FFA), Peroxide(PV), DOBI & Carotene content on palm oil	unit	CDR/ ITALY
CDR-225001Z02PLUS	PalmOilTester Plus version , determination of Acidity (FFA), Peroxide(PV), Anisidine(AnV), iodine(IV), DOBI & Carotene content on palm oil	unit	CDR/ ITALY
CDR-225006Z01	OxiTester , Analysis system for test of Acidity(FFA), Peroxides(PV)and Poliphenols on vegetable oil	unit	CDR/ ITALY
CDR-225009Z01	FoodLab Fat , Analyzer with analyzer with configuration for test fats and oils (Acidity, peroxide value, soaps and P-anisidine)	unit	CDR/ ITALY
CDR-300120	Reagents- Acidity (FFA)	100 Test	CDR/ ITALY
CDR-300129	Reagents- Diluent for Acidity High	100 Test	CDR/ ITALY
CDR-300190	Reagents- Peroxide Value (PV)	100 Test	CDR/ ITALY
CDR-300195	Reagents- Dobi & Carotene Content	100 Test	CDR/ ITALY
CDR-300510	Reagents-p-Anisidine Value (AnV)	100 Test	CDR/ ITALY
CDR-300555	Reagents- Iodine Value (IV)	100 Test	CDR/ ITALY

WiseClave WAC Autoclave JKKP Approved Model

Digital Fuzzy-Controlled Autoclaves- Steam Sterilizer

Catalogue No.	Model	Description
DH-WAC01047	WAC-47 *	Autoclave 47 Litres,230V, Temperature :Ambient 5°C to 132°C
DH-WAC01060	WAC-60 *	Autoclave 60Litres,230V, Temperature :Ambient 5°C to 132°C
DH-WAC01080	WAC-80 *	Autoclave 80 Litres,230V, Temperature :Ambient 5°C to 132°C

* Include 2 Wire Baskets, Stainless Steel Chamber

WiseBath® WB Water Baths, General Purpose

Digital Precise Water Bath

Catalogue No.	Model	Description
DH-WB000106	WB-6	Water Bath with Flat Lid, 6 Lit., 800W
DH-WB000111	WB-11	Water Bath with Flat Lid, 11 Lit., 1.2kW
DH-WB000115	WB-15	Water Bath with Flat Lid, 15 Lit.
DH-WB000122	WB-22	Water Bath with Flat Lid, 22 Lit., 2.0kW

Accessories for Water Bath

DH-WB010106	BF106	Flat Lid, Stainless Steel for 6 Lit.
DH-WB010111	BF111	Flat Lid, Stainless Steel for 11 Lit.
DH-WB010122	BF122	Flat Lid, Stainless Steel for 22 Lit.
DH-WB010206	BD206	Domed Lid, Stainless Steel for 6 Lit.
DH-WB010211	BD211	Domed Lid, Stainless Steel for 11 Lit.
DH-WB010222	BD222	Domed Lid, Stainless Steel for 22 Lit.

WiseCircu® WCB Circulation Water Baths

Digital Precise Circulation Water Bath

Catalogue No.	Model	Description
DH-WCB00106	WCB-6	Circulation Water Bath, 6 Lit., 800W
DH-WCB00111	WCB-11	Circulation Water Bath, 11 Lit., 1.2kW
DH-WCB00122	WCB-22	Circulation Water Bath, 22 Lit., 2kW

Immersion Circulator Head Only

DH-WCB10011	WCB-11H	Immersion Circulator Head 1.2 kW
DH-WCB10022	WCB-22H	Immersion Circulator Head 2 kW

WiseBath® WEB Extraction Water Baths

Multi-Purpose (Extraction) Water Bath

Catalogue No.	Model	Description
DH-WEB01004	WEB-4	Extraction Water Bath, 4 Places, with Holding Frame, 2 kW
DH-WEB01006	WEB-6	Extraction Water Bath, 6 Places, with Holding Frame, 3 kW
DH-WEB01008	WEB-8	Extraction Water Bath, 8 Places, with Holding Frame, 3 kW

WiseBath® WMB 3-Chamber Water Baths

Digital Multi-Chamber Water Bath

Catalogue No.	Model	Description
DH-WMB01306	WMB-306	3-Chamber Water Bath 6 Litres, with Flat Lid
DH-WMB01311	WMB-311	3-Chamber Water Bath 11 Litres, with Flat Lid

WiseBath® WHB High-Temp. Oil Baths

Digital High Temp. Oil Bath

Catalogue No.	Model	Description
DH-WHB00106	WHB-6	High Temp. Oil Bath 6 Litres, with Cover
DH-WHB00111	WHB-11	High Temp. Oil Bath 11 Litres, with Cover
DH-WHB00122	WHB-22	High Temp. Oil Bath 22 Litres, with Cover

WiseCircu® WCR Refrigerated Bath Circulators

Digital Precision Refrigerated Bath Circulator, -20°C to 100°C

Catalogue No.	Model	Description
DH-WCR00206	WCR-P6	Refrigerated Circulator, 6 Lit., -20° to 100°, 800W
DH-WCR00208	WCR-P8	Refrigerated Circulator, 8 Lit., -20° to 100°, 1kW
DH-WCR00212	WCR-P12	Refrigerated Circulator, 12 Lit., -20° to 100°, 1.5kW
DH-WCR00222	WCR-P22	Refrigerated Circulator, 22 Lit., -20° to 100°, 2kW
DH-WCR00230	WCR-P30	Refrigerated Circulator, 30 Lit., -20° to 100°, 2.5kW

WiseCircu® WCL Refrigerated Bath Circulators

Ultra Low-Temp. Refrigerated Bath Circulator, -40°C to 100°C

Catalogue No.	Model	Description
DH-WCL00206	WCL-P6	Refrigerated Bath Circulator, 6 Lit., -40° to 100°, 800W
DH-WCL00208	WCL-P8	Refrigerated Bath Circulator, 8 Lit., -40° to 100°, 1kW
DH-WCL00212	WCL-P12	Refrigerated Bath Circulator, 12 Lit., -40° to 100°, 1.5kW
DH-WCL00222	WCL-P22	Refrigerated Bath Circulator, 22 Lit., -40° to 100°, 2kW
DH-WCL00230	WCL-P30	Refrigerated Bath Circulator, 30 Lit., -40° to 100°, 2.5kW

WiseCircu® WCT-40 Cold Trap Baths

Digital Precision Cold Trap Bath

Catalogue No.	Model	Description
DH-WCT00140	WCT-40	Cold Trap Bath with Glass Cold Trap 10 Lit., -40°C
DH-WCT00180	WCT-80	Cold Trap Bath with Glass Cold Trap 10 Lit., -80°C

WiseCircu® WSB Shaking Water Baths

Digital Precise Shaking Water Bath

Catalogue No.	Model	Description
DH-WSB01018	WSB-18	Shaking Water Bath, 18 Litres, with Spring Rack
DH-WSB01030	WSB-30	Shaking Water Bath, 30 Litres, with Spring Rack
DH-WSB01045	WSB-45	Shaking Water Bath, 45 Litres, with Spring Rack
Accessories for Shaking Water Bath		
DH-WSB02018	WSB02018	Domed Lid, Stainless Steel, for 18 Litres Bath
DH-WSB02030	WSB02030	Domed Lid, Stainless Steel, for 30 Litres Bath
DH-WSB02045	WSB02045	Domed Lid, Stainless Steel, for 45 Litres Bath

WiseCircu® WVB Viscosity Water Baths

Digital Precise Viscosity Water Bath

Catalogue No.	Model	Description
DH-WVB01030	WVB-30	Viscosity Water Bath 30 litres
DH-WVB01052	WVB-52	Viscosity Water Bath 52 litres
Accessories for Viscosity Water Bath		
DH-WVB02010	WVB02010	Viscometer Holder

WiseSpin® CF-5 Table Top Micro Centrifuges

Mini Personal Table Top Centrifuge

Catalogue No.	Model	Description
DH-WCF00005	CF-5	Mini Personal Table Top Centrifuge, 5000 rpm, 0.2/1.5x2.0ml Tube, Two 8-Strip 0.2ml PCR Tube Rotor

WiseSpin® CF-10 Table Top Micro Centrifuges

High Performance Personal Table Top Centrifuge

Catalogue No.	Model	Description
DH-WCF00010	CF-10	Personal Table Top Centrifuge, 13500 rpm, incl. CFAR1512, 230V
Accessories for Centrifuge		
DH-WCF00100	CFAR1512	Angle Rotor for CF-10, 12 x 1.5x 2.0ml tubes

WiseDoc® Gel Documentation System

WGD-20 Gel Documentation System

Catalogue No.	Model	Description
DH-WGD00024	WGD-20S	Gel Doc.System, with 1.5M Camera, Darkroom and Analysis Software
WGD-30 Unified Gel Documentation System		
DH-WGD00034	WGD-30S	Gel Doc.System, unified with 1.5M Camera, Darkroom and Transilluminator(WUV-M20) and Analysis Software

WiseUV® WUV UV Transilluminator

UV Transilluminator, Standard Type

Catalogue No.	Model	Description
DH-WUV00010	WUV-L10	UV Transilluminator 20 x 20cm Filter, 365nm, 15W x 6pcs
DH-WUV00020	WUV-L20	UV Transilluminator 20 x 20cm Filter, 312nm, 15W x 6pcs
DH-WUV00050	WUV-L50	UV Transilluminator 20 x 20cm Filter, 365nm + 312nm, 15W x 6pcs
UV Transilluminator, Mini Type		
DH-WUV00110	WUV-M10	UV Transilluminator, 20x20 cm filter, 365nm,
DH-WUV00120	WUV-M20	UV Transilluminator, 20x20 cm filter, 312nm

WiseTherm® F/FH Furnaces

Digital Muffle Furnace, Standard Type 1000°C

Catalogue No.	Model	Description
DH-WF11.03	F-03	Furnace, 1000°C, 3Lit., 1.8kW
DH-WF11.05	F-05	Furnace, 1000°C, 4.5Lit., 2.6kW
DH-WF11.12	F-12	Furnace, 1000°C, 12Lit., 4.4kW
DH-WF11.14	F-14	Furnace, 1000°C, 14Lit., 4.6kW
DH-WF11.27	F-27	Furnace, 1000°C, 27Lit., 6.2kW
DH-WF11.63	F-63	Furnace, 1000°C, 63Lit., 11.1kW
Digital Muffle Furnace, Standard type 1200°C		
DH-WFH12.03	FH-03	Furnace, 1200°C, 3Lit., 1.8kW
DH-WFH12.05	FH-05	Furnace, 1200°C, 4.5Lit., 2.6kW
DH-WFH12.12	FH-12	Furnace, 1200°C, 12Lit., 4.4kW
DH-WFH12.14	FH-14	Furnace, 1200°C, 14Lit., 4.6kW
DH-WFH12.27	FH-27	Furnace, 1200°C, 27Lit., 6.2kW
DH-WFH12.63	FH-63	Furnace, 1200° C, 63Lit., 11.1kW

WiseTherm® FP/FHP Furnaces

Programmable Digital Muffle Furnace, 1000°C

Catalogue No.	Model	Description
DH-WF11.P03	FP-03	Programmable Furnace, 1000°C, 3Lit., 1.8kW
DH-WF11.P05	FP-05	Programmable Furnace, 1000°C, 4.5Lit., 2.6kW
DH-WF11.P12	FP-12	Programmable Furnace, 1000°C, 12Lit., 4.4kW
DH-WF11.P14	FP-14	Programmable Furnace, 1000°C, 14Lit., 4.6kW
DH-WF11.P27	FP-27	Programmable Furnace, 1000°C, 27Lit., 6.2kW
DH-WF11.P63	FP-63	Programmable Furnace, 1000°C, 63Lit., 11.1kW
Programmable Digital Muffle Furnace, 1200°C		
DH-WFH12.P03	FHP-03	Programmable Furnace, 1200°C, 3Lit., 1.8kW
DH-WFH12.P05	FHP-05	Programmable Furnace, 1200°C, 4.5Lit., 2.6kW
DH-WFH12.P12	FHP-12	Programmable Furnace, 1200°C, 12Lit., 4.4kW
DH-WFH12.P14	FHP-14	Programmable Furnace, 1200°C, 14Lit., 4.6kW
DH-WFH12.P27	FHP-27	Programmable Furnace, 1200°C, 27Lit., 6.2kW
DH-WFH12.P63	FHP-63	Programmable Furnace, 1200°C, 63Lit., 11.1kW

WiseTherm® HB/HB-R Dry Baths

High-Performance Dry Bath- Heating

Catalogue No.	Model	Description
DH-WHB00148	HB-48	Digital Heating Block w/o Block
DH-WHB00149	HB-48-Set	HB-48 Package ,with Block (BLC548) for 1.5ml 48 tubes
DH-WHB00196	HB-96	Digital Heating Block w/o Block
DH-WHB00197	HB-96-Set	HB-96 Package ,with 2 x Block (BLC548) for 1.5ml 48 tubes
DH-WHB00198	HB-96D	Digital Heating Block, Dual Control, w/o Block
DH-WHB00199	HB-96D-Set	HB-96D Package ,with 2 x Block (BLC548) for 1.5ml 48 tubes
DH-WHB00248	HBR-48	Digital Bath Heating&Cooling Block w/o block
DH-WHB00249	HB-R48-Set	HB-R48-Set Package ,with Block (BLC548) for 1.5ml 48 tubes
Accessories for Heating Block		
DH-WHB510570	BLC570	Block, 0.5 ml Centrifuge Tube, 63 holes
DH-WHB511548	BLC548	Block, 1.5 ml Centrifuge Tube, 48 holes
DH-WHB521248	BLT248	Block, Φ12 Test Tube, 48 holes
DH-WHB521335	BLT335	Block, Φ13 Test Tube, 35 holes
DH-WHB521535	BLT535	Block, Φ15 Test Tube, 30 holes
DH-WHB521628	BLT628	Block, Φ16.5 Test Tube, 24 holes
DH-WHB521828	BLT828	Block, Φ18 Test Tube, 24 holes
DH-WHB531515	BLC515	Block, 15 ml Conical Tube, 15 holes
DH-WHB535008	BLC008	Block, 50 ml Conical Tube, 8 holes
DH-WHB500101	BLE101	Block Extraction Tong

WiseTis® Homogenizer

HG-15A Homogenizer with Direct Controller, Analog Type

Catalogue No.	Model	Description
DH-WHG02015	HG-15A-Unit	Homogenizer 1-2500ml, Analog Controller w/o Dispersing Tool
DH-WHG02016	HG-15A-Set-A	HG-15A Package with CL200, ST110, HT1018
DH-WHG02017	HG-15A-Set-B	HG-15A Package with CL200, ST110, HT1025
HG-15D Digital Homogenizer with Remote Controller		
DH-WHG02018	HG-15D-Unit	Homogenizer 1-2500ml, Digital Remote Control w/o Dispersing Tool
DH-WHG02019	HG-15D-Set-A	HG-15D Package with CL200, ST110, HT1018
DH-WHG02020	HG-15D-Set-B	HG-15D Package with CL200, ST110, HT1025
Dispersing Tool for Homogenizer		
DH-WHG02108	HT1008	Homogenizer Tool, Rotor Φ6.1, Stator Φ8, 1~50 ml
DH-WHG02110	HT1010	Homogenizer Tool, Rotor Φ7.5, Stator Φ10, 1~100 ml
DH-WHG02118	HT1018	Homogenizer Tool, Rotor Φ12.7, Stator Φ18, 10~1000 ml
DH-WHG02125	HT1025	Homogenizer Tool, Rotor Φ17, Stator Φ25, 50~2500 ml
HS-30E Homogenizing Stirrer		
DH-WOS01010	HS-30E-Unit	Homogenizing Stirrer 200-500 rpm
DH-WOS01011	HS-30E-Set	HS-30E Package with CL200 & ST110

WiseCube® Digital Incubators

WiseCube®WIM, Multi-Room Incubator

Catalogue No.	Model	Description
DH-WIM04125	WIM-4	Multi-Room Incubator 125Litres x 4 Rooms, Ambient +5°C to 60°C
DH-WIM14125	WIM-R4	Multi-Room Incubator 125Litres x 4 Rooms, 0°C to 60°C
DH-WIM24125	WIM-RL4	Multi-Room Incubator 125Litres x 4 Rooms, FL Lamps, 0°C to 60°C
WiseCube® WGC, Programmable Plant Growth Chamber		
DH-WGC00450	WGC-450	Plant Growth Chamber 432 Litres, 10-60°C, 30-95% RH, 0-12000 Lux
DH-WGC01000	WGC-1000	Plant Growth Chamber 864 Litres, 10-60°C, 30-95% RH, 0-15000 Lux
WiseCube® WGC, Programmable Growth / Environmental Chamber		
DH-WGC01400	WGC-P4	Prog. Growth Chamber 432 Litres, 10-60°C, 30-95% RH, 0-20000 Lux
DH-WGC01900	WGC-P9	Prog.Growth Chamber 972 Litres, 10-60°C, 30-95% RH, 0-20000 Lux
WiseCube® WIS, Precise Shaking Incubator, Bench Top Type		
DH-WIS02010	WIS-20	Shaking Incubator, Ambient +5 to 60°C, with SP600
DH-WIS02011	WIS-20R	Shaking Incubator, 10 to 60°C, with SP600
WiseCube® WIS, Precise Shaking Incubator, Top Door Type		
DH-WIS01010	WIS-10	Shaking Incubator, Ambient +5 to 60°C, with SP610
DH-WIS01011	WIS-10R	Shaking Incubator, 10 to 60°C, with SP610
DH-WIS01012	WIS-10RL	Shaking Incubator, 10 to 60°C, with SP610 & Illuminators
DH-WIS01013	WIS-10RLC	Shaking Incubator, 10 to 60°C, with SP610 & Illuminator & Recorder
WiseCube® WIS, Precise Shaking Incubator, Top Door Type		
DH-WIS03010	WIS-30	Shaking Incubator, Ambient +5 to 60°C, with SP620
DH-WIS03011	WIS-30R	Shaking Incubator, 10 to 60°C, with SP620
WiseCube® WIS, Multi-Stack Refrigerated Shaking Incubator		
DH-WIS05002	WIS-ML02	Multi-Stack Shaking Incubator, 2 Stacks, 10 to 60°C 20 - 250 rpm, with SP620 x 2
DH-WIS05004	WIS-ML04	Multi-Stack Shaking Incubator, 4 Stacks, 10 to 60°C 20 - 250 rpm, with SP620 x 4
Accessories for Shaking Incubator		
DH-WIS04500	SR500	Universal Spring Rack for WIS-S20 (R)
DH-WIS04600	SP600	Universal Platform for WIS-S20(R)
DH-WIS04510	SR510	Universal Spring Rack for WIS-10 (R/RL/RLC)
DH-WIS04610	SP610	Universal Platform for WIS-10 (R/RL/RLC)
DH-WIS04520	SR520	Universal Spring Rack for WIS-ML02/04
DH-WIS04620	SP620	Universal Platform for WIS-ML02/04
DH-WIS04530	SR530	Universal Spring Rack for WIS-30®
DH-WIS04630	SP630	Universal Platform for WIS-30®

WiseCube® WTH Temp./ Humidity Chamber

Programmable Temp./ Humidity Chamber -20°C to 80°C

Catalogue No.	Model	Description
DH-WTH01155	WTH-155	Temp. / Humidity Chamber, 155Lit., -20°C to 80°C
DH-WTH01305	WTH-305	Temp. / Humidity Chamber, 305Lit., -20°C to 80°C
DH-WTH01420	WTH-420	Temp. / Humidity Chamber, 420Lit., -20°C to 80°C
DH-WTH01800	WTH-800	Temp. / Humidity Chamber, 800Lit., -20°C to 80°C
Programmable Temp./ Humidity Chamber -40°C to 80°C		
DH-WTH02155	WTH-L155	Temp. / Humidity Chamber, 155Lit., -40°C to 80°C
DH-WTH02305	WTH-L305	Temp. / Humidity Chamber, 305Lit., -40°C to 80°C
DH-WTH02420	WTH-L420	Temp. / Humidity Chamber, 420Lit., -40°C to 80°C
DH-WTH02800	WTH-L800	Temp. / Humidity Chamber, 800Lit., -40°C to 80°C
Accessories for Temp. & Humidity Chamber		
DH-WTH05100	WTH5100	Temperature & Humidity Recorder
DH-WTH05105	WTH5105	Chart Paper

WiseVen® Ovens

WiseVen® WOC, Hi-Clean Air Ovens

Catalogue No.	Model	Description
DH-WOC00560	WOC-560	Hi-Clean Air Oven 560 Litres
DH-WOC00800	WOC-800	Hi-Clean Air Oven 800 Litres
Accessories for Hi-Clean Air Oven		
DH-WOCN2GIN	WOCN2GIN	N2 Gas Inlet Device for WOC
DH-WTH05010	WTH5010	RS-485 PC Communication Interface

WiseVen® WOF-L Industrial Forced Convection Oven

DH-WOFL0400	WOF-L400	Industrial Forced Convection Oven 486 Litres
DH-WOFL0800	WOF-L800	Industrial Forced Convection Oven 840 Litres
DH-WOFL1000	WOF-L1000	Industrial Forced Convection Oven 1176 Litres

WiseCube® WCC Refrigerator Cold Lab Chambers

Digital Cold Lab Chamber 0°C to 10°C

DH-WCC00250	WCC-250	Cold Lab Chamber 250 Litres, 0 - 10°C
DH-WCC01000	WCC-1000	Cold Lab Chamber 1176 Litres, 0 - 10°C

WiseCube® WLF Refrigerator Freezer

Digital Laboratory Freezer Ambient to -35°C

DH-WLF00420	WLF-420	Lab Freezer 420 Litres, Ambient to -35°C
-------------	---------	--

WiseCryo® WUF-D/WUF Digital Ultra-Low Temperature Freezer

DH-WUF01300	WUF-D300	Ultra low Temp. Freezer, Upright, 308 Lit., -95°C
DH-WUF01400	WUF-D400	Ultra low Temp. Freezer, Upright, 393 Lit., -95°C
DH-WUF01500	WUF-D500	Ultra low Temp. Freezer, Upright, 503 Lit., -95°C
DH-WUF01700	WUF-D700	Ultra low Temp. Freezer, Upright, 683 Lit., -95°C

WiseCryo® WUF-D/WUF Digital Ultra-Low Temperature Freezer, -86°C, Upright

DH-WUF00300	WUF-300	Ultra low Temp. Freezer, Upright, 308 Lit., -86°C
DH-WUF00400	WUF-400	Ultra low Temp. Freezer, Upright, 393 Lit., -86°C
DH-WUF00500	WUF-500	Ultra low Temp. Freezer, Upright, 503 Lit., -86°C

WiseCryo® WUF-D/WUF Digital Ultra-Low Temperature Freezer, -86°C, Chest

DH-WUF00011	WUF-11	Ultra low Temp. Freezer, Chest, 136 Lit., -86°C
DH-WUF00021	WUF-21	Ultra low Temp. Freezer, Chest, 273 Lit., -86°C
DH-WUF00031	WUF-31	Ultra low Temp. Freezer, Chest, 314 Lit., -86°C
DH-WUF00041	WUF-41	Ultra low Temp. Freezer, Chest, 375 Lit., -86°C
DH-WUF00051	WUF-51	Ultra low Temp. Freezer, Chest, 438 Lit., -86°C

WiseMix® RK Digital Rockers

Catalogue No.	Model	Description
DH-WRK01010	RK-1D	Digital Rocker 290 x 200mm Platform
DH-WRK01020	RK-2D	Digital Rocker 300 x 300mm Platform
Accessories for Rocker		
DH-WRK05011	RK5011	Second Platform for RK-1D, 290 x 200mm with 4 Pillar
DH-WRK05021	RK5021	Second Platform for RK-2D, 300 x 300mm with 4 Pillar

WiseShake® Digital Shakers

SHO Digital Orbital Shaker

Catalogue No.	Model	Description
DH-WSO04010	SHO-1D	Digital Orbital Shaker, 10~300rpm, 230 x 230mm w/o Platform
DH-WSO04012	SHO-2D	Digital Orbital Shaker, 10~300rpm, 350 x 350mm w/o Platform
WiseShake® SHR Digital Reciprocating Shaker		
DH-WSR04020	SHR-1D	Digital Reciprocating Shaker, 10~300rpm, 230 x 230mm w/o Platform
DH-WSR04022	SHR-2D	Digital Reciprocating Shaker, 10~300rpm, 350 x 350mm w/o Platform
Accessories for Shaker		
DH-WSO504100	SP100	Universal Platform for SHO/SHR-1D, w230xd230mm
DH-WSO504110	SP110	Rubber Mat Platform for SHO/SHR-1D, w270xd270mm
DH-WSO504200	SP200	Universal Platform for SHO/SHR-2D, w350xd350mm
DH-WSO504210	SP210	Rubber Mat Platform for SHO/SHR-2D, w370xd370mm,
DH-WIS04030	FH100	Flask Holder for Shaker, 50 - 100ml
DH-WIS04035	FH250	Flask Holder for Shaker, 200 - 300ml
DH-WIS04040	FH500	Flask Holder for Shaker, 500 - 1000ml

WiseStir® Overhead Stirrers

WiseStir® HS-A Overhead Stirrer, Analog-type, High Speed

Catalogue No.	Model	Description
DH-WOS01210	HS-50A-Unit	Overhead Stirrer, High Speed, 3000rpm, 75W
DH-WOS01211	HS-50A-Set	OS HS-50A Package (Incl. PL010, CL200, KA1177)
DH-WOS01215	HS-120A-Unit	Overhead Stirrer, High Speed, 3000rpm, 120W
DH-WOS01216	HS-120A-Set	OS HS-120A Package (Incl. PL015, CL200, KA1177)
WiseStir® HS-D Digital Feedback-Controlled Stirrer, High Speed		
DH-WOS01015	HS-30D-Unit	Overhead Stirrer, High Speed, 3000rpm, 75W
DH-WOS01016	HS-30D-Set	OS HS-30D Package (Incl. PL010, CL200, ST110)
DH-WOS01025	HS-100D-Unit	Overhead Stirrer, High Speed, 3000rpm, 120W
DH-WOS01026	HS-100D-Set	OS HS-100D Package (Incl. PL015, CL200, ST120)
WiseStir® HS-T Digital Feedback-Controlled Stirrer, Remote Controlled, High Speed		
DH-WOS01035	HS-30T-Unit	Overhead Stirrer, High Speed, 3000rpm, 75W with Remote Control
DH-WOS01036	HS-30T-Set	OS HS-30T Package (Incl. PL010, CL200, ST110)
DH-WOS01045	HS-100T-Unit	Overhead Stirrer, High Speed, 3000rpm, 120W with Remote Control
DH-WOS01046	HS-100T-Set	OS HS-100T Package (Incl. PL015, CL200, ST120)
WiseStir® HT-AX Overhead Stirrer, Analog-type, High Torque		
DH-WOS01251	HT-50AX-Unit	Overhead Stirrer, High Torque 300 Ncm, 75W
DH-WOS01252	HT-50AX-Set	OS HT-50AX Package (Incl. PL020, CL200, KA1177)
DH-WOS01271	HT-120AX-Unit	Overhead Stirrer, High Torque 500 Ncm, 120W
DH-WOS01272	HT-120AX-Set	OS HT-120AX Package (Incl. PL020, CL200, KA1177)
Feedback-Controlled Stirrer, High Torque		
DH-WOS01051	HT-50DX-Unit	Overhead Stirrer, High Torque 300 Ncm, 75W
DH-WOS01052	HT-50DX-Set	OS HT-50DX Package (Incl. PL020, CL200, ST120)
DH-WOS01071	HT-120DX-Unit	Overhead Stirrer, High Torque, 120W
DH-WOS01072	HT-120DX-Set	OS HT-120DX Package (Incl. PL020, CL200, ST200)
WiseStir® HT-T Digital Feedback-Controlled Stirrer, Remote Control, High Torque		
DH-WOS01065	HT-50T-Unit	Overhead Stirrer, High Torque 300 Ncm, 75W, Remote Control
DH-WOS01066	HT-50T-Set	OS HT-50T Package (Incl. PL020, CL200, ST120)
DH-WOS01075	HT-120T-Unit	Overhead Stirrer, High Torque 500 Ncm, 120W, Remote Control
DH-WOS01076	HT-120T-Set	OS HT-120T Package (Incl. PL020, CL200, ST200)
Accessories for Overhead Stirrer / Homogenizer		
DH-WOS502020	CL200	Clamp
DH-WOS501510	ST110	Plate Stand with Rod, Standard
DH-WOS501515	ST120	Plate Stand with Rod, Wide
DH-WOS501520	ST200	Deluxe Stand with Rod, H-type, Flexible Feet
DH-WOS1177	KA1177	Deluxe Stand with Rod, U-type

WiseStir® Overhead Stirrers

Stirring Tools with Exchangeable Blades for Overhead Stirrers

Catalogue No.	Model	Description
For Both High Speed and High Torque Models		
Propeller-types 3 x Bladed		
DH-WOS501010	PL010	Impeller, Propeller, 3-bladed, Dia. 40mm Blade
DH-WOS501011	PL011	Impeller, Propeller, 3-bladed, Dia. 60mm Blade
DH-WOS501012	PL012	Impeller, Propeller, 3-bladed, Dia. 80mm Blade
DH-WOS501013	PL013	Impeller, Propeller, 3-bladed, Dia. 100mm Blade
Propeller-types 4 x Bladed		
DH-WOS501015	PL015	Impeller, Propeller, 4-bladed, Dia. 70mm Blade
DH-WOS501016	PL016	Impeller, Propeller, 4-bladed, Dia. 90mm Blade
DH-WOS501017	PL017	Impeller, Propeller, 4-bladed, Dia. 1100mm Blade
Diamond-types 4 x Bladed		
DH-WOS501020	PL020	Impeller, Diamond, 4-bladed, Dia. 90mm Blade
DH-WOS501021	PL021	Impeller, Diamond, 4-bladed, Dia. 100mm Blade
Centrifugal-types 2 x Bladed		
DH-WOS501025	PL025	Impeller, Centrifugal, 2-bladed, Dia. 80mm Blade
Teflon Coated Centrifugal-types 2 x Bladed		
DH-WOS501030	PL030	Impeller, Teflon, 2-bladed, Dia. 90mm Blade
DH-WOS501031	PL031	Impeller, Teflon, 2-bladed, Dia. 120mm Blade
Anchor-types 2 x Bladed		
DH-WOS501035	PL035	Impeller, Anchor, 2-bladed, Dia. 70mm Blade
DH-WOS501036	PL036	Impeller, Anchor, 2-bladed, Dia. 90mm Blade
For High Torque Models (HT-AX, HT-DX, HT-T)		
Propeller-types 3 x Bladed		
DH-WOS501111	PL111	Impeller, Propeller, 3-bladed, Dia. 10mm Rod, Dia. 60mm Blade
DH-WOS501112	PL112	Impeller, Propeller, 3-bladed, Dia. 10mm Rod, Dia. 80mm Blade
DH-WOS501113	PL113	Impeller, Propeller, 3-bladed, Dia. 10mm Rod, Dia. 100mm Blade
Propeller-types 4 x Bladed		
DH-WOS501116	PL116	Impeller, Propeller, 4-bladed, Dia. 10mm Rod, Dia. 90mm Blade
DH-WOS501117	PL117	Impeller, Propeller, 4-bladed, Dia. 10mm Rod, Dia. 110mm Blade
Diamond-types 4 x Bladed		
DH-WOS501121	PL121	Impeller, Diamond, 4-bladed, Dia. 10mm Rod, Dia. 100mm Blade
Anchor-types 2 x Bladed		
DH-WOS501135	PL135	Impeller, Anchor, 2-bladed, Dia. 10mm Rod, Dia. 90mm Blade
DH-WOS501136	PL136	Impeller, Anchor, 2-bladed, Dia. 10mm Rod, Dia. 140mm Blade

WiseClean® WUC Ultrasonic Cleaner - Set

Ultrasonic Cleaner - Set, Analog

Catalogue No.	Model	Description
DH-WUC.A01H	WUC-A01H	Ultrasonic Cleaner, 28 kHz, 1.2 Litres, 60 W
DH-WUC.A02H	WUC-A02H	Ultrasonic Cleaner, 28 kHz, 1.8 Litres, 60 W
DH-WUC.A03H	WUC-A03H	Ultrasonic Cleaner, 40 kHz, 3.3 Litres, 100 W
DH-WUC.A06H	WUC-A06H	Ultrasonic Cleaner, 40 kHz, 6 Litres, 150 W
DH-WUC.A10H	WUC-A10H	Ultrasonic Cleaner, 40 kHz, 10 Litres, 200 W
DH-WUC.A22H	WUC-A22H	Ultrasonic Cleaner, 40 kHz, 22 Litres, 300 W
Digital Ultrasonic Cleaner-Set		
DH-WUC.D06H	WUC-D06H	Ultrasonic Cleaner, 40 kHz, 6 Litres, 150 W, with Basket
DH-WUC.D10H	WUC-D10H	Ultrasonic Cleaner, 40 kHz, 10 Litres, 200 W, with Basket & Drain Valve
DH-WUC.D22H	WUC-D22H	Ultrasonic Cleaner, 40 kHz, 22 Litres, 200 W, with Basket & Drain Valve
Accessories for Ultrasonic Cleaner		
DH-WUC.B02	B02	Basket, Stainless Steel, for WUC-A02H (1.8 Litres)
DH-WUC.B03	B03	Basket, Stainless Steel, for WUC-A03H (3.3 Litres)
DH-WUC.B06	B06	Basket, Stainless Steel, for WUC-A06H / -D06H (6 Litres)
DH-WUC.B10	B10	Basket, Stainless Steel, for WUC-A10H / -D10H (10 Litres)
DH-WUC.B22	B22	Basket, Stainless Steel, for WUC-A22H / -D22H (22 Litres)

WiseStir® / WiseTherm® Digital Precise Magnetic Stirrer / Hotplate

WiseStir® MSH-A, Premium Hotplate Stirrer, Analog Type

Catalogue No.	Model	Description
DH-WMH03120	MSH-20A	Hotplate Stirrer, Analog, 180 x 180mm, 0-1500 rpm, to 380°C
DH-WMH03121	MSH-30A	Hotplate Stirrer, Analog, 260 x 260mm, 0-1500 rpm, to 380°C

WiseStir® MSH-D, Digital Hotplate Stirrer

DH-WMH03020	MSH-20D-Unit	Digital Hotplate Stirrer, 180 x 180mm, 80-1500 rpm, to 380°C
DH-WMH03021	MSH-20D-Set	MSH-20D Package w/ SS200, RD200, CL220
DH-WMH03022	MSH-30D-Unit	Digital Hotplate Stirrer, 260 x 260mm, 80-1500 rpm, to 380°C
DH-WMH03023	MSH-30D-Set	MSH-30D Package w/ SS200, RD200, CL220

WiseStir® MS-20A, Premium Magnetic Stirrer, Analog Type

DH-WMS03122	MS-20A	Analog Magnetic Stirrer, 0 - 1500 rpm
-------------	--------	---------------------------------------

WiseStir® MS-20D, Digital Magnetic Stirrer

DH-WMS03022	MS-20D	Digital Magnetic Stirrer, 80 - 1500 rpm
-------------	--------	---

WiseTherm® HP-A, Premium Hotplate, Analog Type

Catalogue No.	Model	Description
DH-WHP03120	HP-20A	Hotplate, Analog, 180 x 180, to 380°C
DH-WHP03121	HP-30A	Hotplate, Analog, 260 x 260, to 380°C

WiseTherm® HP-D, Digital Precise Hotplate

Catalogue No.	Model	Description
DH-WHP03020	HP-20D-Unit	Digital Hotplate, 180 x 180mm, to 380°C
DH-WHP03021	HP-20D-Set	HP-20D Package w/ SS200, RD200, CL220
DH-WHP03022	HP-30D-Unit	Digital Hotplate, 260 x 260mm, to 380°C
DH-WHP03023	HP-30D-Set	HP-30D Package w/ SS200, RD200, CL220

WiseTherm® HP-LD, Premium Large Digital Hotplate

DH-WHP03024	HP-LP1	Large Digital Hotplate, 620 x 310mm, to 380°C, Ceramic Coated
DH-WHP03025	HP-LP1-Set	HP-LP1 Package, with Remote Controller
DH-WHP03027	HP-LP2	Large Digital Hotplate, 620 x 310mm, to 380°C, Anodized
DH-WHP03028	HP-LP2-Set	HP-LP2 Package, with Remote Controller

WiseStir® MS-MP Digital Multi-Point Magnetic Stirrer

Catalogue No.	Model	Description
DH-WMS03036	MS-MP4	Multipoint Magnetic Stirrer, 4 Points, 80 - 1200 rpm
DH-WMS03038	MS-MP8	Multipoint Magnetic Stirrer, 8 Points, 80 - 1200 rpm

WiseStir® SMHS Systematic Multi-Hotplate Stirrer

DH-WMH03503	SMHS-3	Multiple Hotplate Stirrer, 3 Positions
DH-WMH03506	SMHS-6	Multiple Hotplate Stirrer, 6 Positions

Accessories for Hotplate / Hotplate Stirrer

DH-WHP503020	SS100	Direct Contact PT100 Sensor for SMHS-3 / -6
DH-WHP503021	SS110	Teflon Coated Temp. Sensor for SMHS-3 / -6
DH-WHP503030	SS200	Direct Contact PT100 Sensor for MSH-D & HP-D
DH-WHP503031	SS210	Teflon Coated Temp. Sensor for MSH-D & HP-D
DH-WHP503011	RD100	Stand Rod, Stainless Steel for old MSH-10 & MSH-10H
DH-WHP503036	RD200	Stand Rod, Stainless Steel for MSH-D, HP-D & SMHS
DH-WHP503012	CL220	Holder + Clamp

Balances

Summit- SI With Internal Calibration

Applications

Counting, Weighing in Percent, Net total (Formulation), Calculating, Animal weighing/Averaging, Totalising, Density determination, Mass unit conversion, 22 different mass units are available, ISO/GLP-conform protocol, weighing below the balance

Catalogue No.	Model	Description
DI-TB-215D	TB-215D	Analytica 60/210g x 0.01mg/0.1mg, Pan Size Ø80mm
DI-SI-234	SI-234	Analytical 230g x 0.1mg, Pan Size Ø90mm
DI-SI-114	SI-114	Analytical 110g x 0.1mg, Pan Size Ø90mm
DI-SI-64	SI-64	Analytical 60g x 0.1mg, Pan Size Ø90mm
DI-SI-2002	SI-2002	Top Pan 2000g x 0.01g, Pan Size 180x180mm
DI-SI-203	SI-203	Precision 200g x 1mg, Pan Size Ø115mm
DI-SI-402	SI-402	Precision 400g x 1mg, Pan Size Ø115mm
DI-SI-403	SI-403	Precision 400g x 1mg, Pan Size Ø115mm
DI-SI-602	SI-602	Precision 600g x 1mg, Pan Size Ø115mm
DI-SI-603	SI-603	Precision 600g x 1mg, Pan Size Ø115mm
DI-SI-4002	SI-4002	Top Pan 4000g x 0.01g, Pan Size 180x180mm
DI-SI-6002	SI-6002	Top Pan 6000g x 0.01g, Pan Size 180x180mm
DI-SI-4001	SI-4001	Top Pan 4000g x 0.1g, Pan Size 180x180mm
DI-SI-8001	SI-8001	Top Pan 8000g x 0.1g, Pan Size 180x180mm

TP Series With External Calibration

Applications

The TP-line comes with a number of useful application programs helping to simplify your weighing tasks, such as counting, %-weighing, formulation, average weighing, weighing in 19 different weigh units

Catalogue No.	Model	Description
DI-TP-114	TP-114	Analytical 110g x 0.1mg, Pan Size Ø80mm
DI-TP-214	TP-214	Analytical 210g x 0.1mg, Pan Size Ø80mm
DI-TP-213	TP-213	Precision 210g x 1mg, Pan Size Ø100mm
DI-TP-313	TP-313	Precision 310g x 1mg, Pan Size Ø100mm
DI-TP-602	TP-602	Precision 600g x 0.01g, Pan Size Ø116mm
DI-TP-1102	TP-1102	Precision 1100g x 0.01g, Pan Size 174 x 143mm
DI-TP-2102	TP-2102	Precision 2100g x 0.01g, Pan Size 174 x 143mm
DI-TP-3102	TP-3102	Precision 3100g x 0.01g, Pan Size 174 x 143mm
DI-TP-2101	TP-2101	Precision 2100g x 0.1g, Pan Size 174 x 143mm
DI-TP-4101	TP-4101	Precision 4100g x 0.1g, Pan Size 174 x 143mm
DI-TP-6101	TP-6101	Precision 6100g x 0.1g, Pan Size 174 x 143mm

IR Moisture Analyzers

Catalogue No.	Model	Description
DI-IR-35	IR-35	Moisture Analyzers 35g x 1mg, Pan Size 90mm, Infrared heating elements
DI-IR-60	IR-60	Moisture Analyzers 60g x 1mg, Pan Size 90mm, CQR quartz heater
DI-IR-120	IR-120	Moisture Analyzers 120g x 1mg, Pan Size 90mm, CQR quartz glass radiator



Catalogue No.	Description	UOM	Brand
ENC-INDR	LIVI Industrial Roll Hand Towel , Pure Pulp & Perforated, 26cm x 1000M x 1ply (Packing: 2rolls x 1 ctn)	rolls	ENC/ MALAYSIA
ENC-ST-01	Industrial Roll Floor Stand	rolls	ENC/ MALAYSIA

FAVORIT, MALAYSIA



Water Stills

Catalogue No.	Model	Description
P21001	W4L	Basic Water Still with Metal Heater, 4 Litres / Hour
P21003	WCS4L	Cabinet Water Still with Silica Heater, 4Litres / Hour
P21004	WCM4L	Cabinet Water Still with Metal Heater, 4Litres / Hour
P21006	WCS8L	Cabinet Water Still with Silica Heater, 8 Litres / Hour

Hotplate, Magnetic Stirrer & Hotplate Stirrer

Catalogue No.	Model	Description
Hotplate		
P22002	HP0707V2	Hotplate with Solid Ceramic Top, 950W , Top plate area :7" x 7" Max. plate surface temperature : Approx. 520°C Electrical supply requirement : 230 V a.c.
Magnetic Stirrer		
P22005	ST0707V2	Magnetic Stirrer with Solid Ceramic Top, 57W, Top plate area :7" x 7" Stirrer speed range, unloaded : Approx. 100 to 1500 rpm Electrical supply requirement : 230 V a.c.
Hotplate Stirrer		
P22008	HS0707V2	Stirring Hotplate with Solid Ceramic Top,1007W,Top plate area :7" x 7" Max. plate surface temperature : Approx. 520°C Stirrer speed range, unloaded : Approx. 100 to 1500 rpm Electrical supply requirement : 230 V a.c.

Mechanical Pipettors

Catalogue No.		Description
Fixed Volume		
New Cat.No.	Old Cat.No.	
	722001PR *	5µl
772004		10µl
772010	722010PR *	20µl
772015	722015PR *	25µl
	722020PR *	50µl
	722025PR *	100µl
	722030PR *	200µl
772035	722035PR *	250µl
	722040PR *	500µl
772045		1000µl
772050	722050PR *	2000µl
	722055PR *	5000µl
Variable Volume		
	720005PR *	0.1 - 2.5µl
	720000PR *	0.5 - 10µl
	720080PR *	2 - 20µl
	720020PR *	5 - 50µl
770030		50 - 200µl
770050		10 - 100µl
770070		20 - 200µl
770110		1000 - 5000µl
770060		100 - 1000µl
Stand for Mechanical Pipettors		
D721005	Stand for 5 Mechanical Pipettors	

Safety Cabinet

PSCF115	SCF115	Safety Cabinet For Flammable Products, 330Liter,Colour: Yellow, 2 adjustable shelf & 1 base trough, 120kg
PSCF250	SCF250	Safety Cabinet For Flammable Products, 650Liter,Colour: Yellow, 3 adjustable shelves & 1 base trough, 165kg

FAVORIT®

Heating Mantle

MS-E, With Temperature Controller

Catalogue No.	Description
MS-E1005	Heating Mantle 50 ml
MS-E101	Heating Mantle 100 ml
MS-E102	Heating Mantle 250 ml
MS-E103	Heating Mantle 500 ml
MS-E104	Heating Mantle 1000 ml
MS-E105	Heating Mantle 2000 ml
MS-E106	Heating Mantle 3000 ml
MS-E107	Heating Mantle 5000 ml
MS-E108	Heating Mantle 10000 ml
MS-E109	Heating Mantle 20000 ml

Temperature Controller

Catalogue No.	Description
MS-TC130D	TC 130 D
MS-TC200	TC 200
MS-TC200P	TC 200 P
MS-TC9201	TC 9201
MS-TC9203	TC 9203
MS-INF100	INF 100

MS-ES, Rotamantle (Heating & Stirring) With Temperature Controller

Catalogue No.	Description
MS-ES3005	Rotamantle 50 ml
MS-ES301	Rotamantle 100 ml
MS-ES302	Rotamantle 250 ml
MS-ES303	Rotamantle 500 ml
MS-ES304	Rotamantle 1000 ml
MS-ES305	Rotamantle 2000 ml
MS-ES306	Rotamantle 3000 ml
MS-ES307	Rotamantle 5000 ml
MS-ES308	Rotamantle 10000 ml
MS-ES309	Rotamantle 20000 ml

Heating Tape

Catalogue No.	Description
MS-HT1006	1" x 60cm
MS-HT1010	1" x 1M
MS-HT1015	1" x 1.5M
MS-HT1020	1" x 2M
MS-HT1025	1" x 2.5M
MS-HT1030	1" x 3M
MS-HT1040	1" x 4M
MS-HT1050	1" x 5M
MS-HT1060	1" x 6M
MS-HT10100	1" x 10M

Digital Mantle

MS-DM, Digital Mantle With Temperature Controller Heating Cord

Catalogue No.	Description
MS-DM6005	Heating Mantle 50 ml
MS-DM601	Heating Mantle 100 ml
MS-DM602	Heating Mantle 250 ml
MS-DM603	Heating Mantle 500 ml
MS-DM604	Heating Mantle 1000 ml
MS-DM605	Heating Mantle 2000 ml
MS-DM606	Heating Mantle 3000 ml
MS-DM607	Heating Mantle 5000 ml
MS-DM608	Heating Mantle 10000 ml
MS-DM609	Heating Mantle 20000 ml

Catalogue No.	Description
MS-HC1206	1/2" x 60cm
MS-HC1210	1/2" x 1M
MS-HC1215	1/2" x 1.5M
MS-HC1220	1/2" x 2M
MS-HC1225	1/2" x 2.5M
MS-HC1230	1/2" x 3M
MS-HC1240	1/2" x 4M
MS-HC1250	1/2" x 5M
MS-HC1260	1/2" x 6M
MS-HC12100	1/2" x 10M

MS-EAM, Soxhlet Mantle

Catalogue No.	Description
MS-EAM9201-03	100 ml - 3 Recesses
MS-EAM9202-03	Ext250 ml - 3 Recesses
MS-EAM9203-03	500 ml - 3 Recesses
MS-EAM9204-03	1000 ml - 3 Recesses
MS-EAM9205-03	2000 ml - 3 Recesses
MS-EAM9201-06	100 ml - 6 Recesses
MS-EAM9202-06	250 ml - 6 Recesses
MS-EAM9203-06	500 ml - 6 Recesses
MS-EAM9204-06	1000 ml - 6 Recesses
MS-EAM9205-06	2000 ml - 6 Recesses

Hotplate & Stirrer

Catalogue No.	Description
MS-100	Hotplate, 180 x 180mm
MS-200	Magnetic Stirrer, 180x180mm
MS-300	Hotplate Stirrer, 180x180mm

Heating Element

Catalogue No.	Description
MS-HT05	Heating Element 50 ml
MS-HT101	Heating Element 100 ml
MS-HT102	Heating Element 250 ml
MS-HT103	Heating Element 500 ml
MS-HT104	Heating Element 1000 ml
MS-HT105	Heating Element 2000 ml
MS-HT106	Heating Element 3000 ml
MS-HT107	Heating Element 5000 ml
MS-HT108	Heating Element 10000 ml
MS-HT109	Heating Element 20000 ml

Centrifuges

Low-Speed Centrifuge- 406G

Catalogue No.	Description	UOM
GZ-0406G	Includes Angle Rotor, GRA-15-6 & 6 Steel Sleeves, GLB-15-FA	
Rotors for 406G		
GZ-GRA-15-6-406	Angle Rotor includes 6 Steel Sleeves, GLB-15-FA, Angle 45°	6 x 15 ml
Steel Sleeves for 406G		
GZ-GLB-15-FA	Steel Sleeves GLB-15-FA 15ml tube	15 ml
Adaptors for 406G		
GZ-GAS-3(15)	3 ml Adaptor for Sleeve GLB-15-FA	3 ml
GZ-GAS-4(15)	4 ml Adaptor for Sleeve GLB-15-FA	4 ml
GZ-GAS-5(15)	5 ml Adaptor for Sleeve GLB-15-FA	5 ml

Low-Speed Centrifuge- 416G

GZ-0416G	Low-Speed General Centrifuge without Rotor (220V, 50/60Hz)	
Rotors for 416G		
GZ-GRS-15-6-416	Swing Rotor, GRS-15-6-416	6 x 15 ml
GZ-GRS-50-4-416	Swing Rotor, GRS-50-4-416	4 x 50 ml
GZ-GRS-b50-4-416	Swing Rotor, GRS-b50-4-416 (for Biosafety)	4 x 50 ml
GZ-GRS-mw-2-416	Swing Rotor, GRS-mw-2 includes 2 Microplate holders	2 MTPs
GZ-GRA-15-16-416	Angle rotor, GRA-15-16-416 includes 16 Steel Sleeves, GLB-15-FA	16 x 15 ml
Steel Sleeve & Buckets for 416G		
GZ-GLB-15-FA	Steel Sleeves, GLB-15-FA	15 ml/1ea
GZ-GLB-15-15	15 ml Bucket for Rotor, GRS-15-6-416	15 ml/1ea
GZ-GLB-15-50	15 ml Bucket for Rotor, GRS-50-4-416	15 ml/1ea
GZ-GLB-c15-50	15 ml Conical Bucket for Rotor, GRS-50-4-416	15 ml Conical/1ea
GZ-GLB-d15-50	2 x 15 ml Bucket for Rotor, GRS-50-4-416	2 x 15 ml/1ea
GZ-GLB-50-50	50 ml Bucket for Rotor, GRS-50-4-416	50 ml/1ea
GZ-GLB-c50-50	50 ml Conical Bucket for Rotor, GRS-50-4-416	50 ml Conical/1ea
GZ-GLB-bd15-b50	2 x 15 ml Bucket for Rotor, GRS-b50-4-416 (for Biosafety)	2 x 15 ml/1ea
GZ-GLB-b50-b50	50 ml Bucket for Rotor, GRS-b50-4-416 (for Biosafety)	50 ml/1ea
GZ-GLB-b85-b50	85 ml Bucket for Rotor, GRS-b50-4-416 (for Biosafety)	85 ml/1ea
GZ-GBL-b50	Bucket Cap for Bucket GLB-bd15-b50 & GLB-b50-b50 (for Biosafety), autoclavable	
GZ-GBL-b85-b50a	Bucket Cap for Bucket GLB-b85-b50 (for Biosafety), autoclavable	
Adaptors for 416G		
GZ-GAS-3(15)	3 ml Adaptor for Sleeve GLB-15-FA	3 ml/1ea
GZ-GAS-4(15)	4 ml Adaptor for Sleeve GLB-15-FA	4 ml/1ea
GZ-GAS-5(15)	5 ml Adaptor for Sleeve GLB-15-FA	5 ml/1ea
GZ-GAS-u15(s50)	15 ml Round & Conical Adaptor for Bucket GLB-50-50	15 ml round or conical/1ea
GZ-GAS-c50(50)	50 ml Conical Adaptor for Bucket GLB-50-50	50 ml conical/1ea

Microcentrifuge 1524M

GZ-1524M	1524M, Microcentrifuge without Rotor (220V, 50/60Hz)	
Rotors for 1524M		
GZ-GRF-m2.0-24-1524	Fixed Angle Rotor, GRF-m2.0-24-1524 with lid	24 x 1.5/2.0 ml
GZ-GRF-s0.2-32-1524	PCR Rotor, GRF-s0.2-32-1524 for PCR strips, 4-rows	32 x 0.2 ml
Adaptors for 1524M		
GZ-GAS-m0.2(2)	0.2 ml Adaptor	0.2 ml/ea
GZ-GAS-m0.5(2)	0.5 ml Adaptor	0.5 ml/ea

Microcentrifuge 1730MR

GZ-1730MR		
Rotors for 1730MR		
GZ-GRF-m2.0-24-1730	Fixed Angle Rotor, GRF-m2.0-24-1730 with lid	24 x 1.5/2.0 ml
GZ-GRF-m2.0-30-1730	Fixed Angle Rotor, GRF-m2.0-30-1730 with lid	30 x 1.5/2.0 ml
GZ-GRF-s0.2-64-1730	PCR Rotor, GRF-s0.2-64-1730 for PCR strips, 8-rows	64 x 0.2 ml
GZ-GRF-s0.2-32-1730	PCR Rotor, GRF-s0.2-32-1730 for PCR strips, 4-rows	32 x 0.2 ml
Adaptors for 1730MR		
GZ-GAS-m0.2(2)	0.2 ml Adaptor	0.2 ml/ea
GZ-GAS-m0.5(2)	0.5 ml Adaptor	0.5 ml/ea

Mini Centrifuge 1312M

GZ-1312M	Mini, Microcentrifuge (220V, 50/60Hz) Includes Fixed Angle Rotor GRF-m2.0-12 & 12 adaptors for 0.2 ml	
Rotors for mini		
GZ-GRF-m2.0-12	Fixed Angle Rotor, GRF-m2.0-12 with lid	12 x 1.5/2.0 ml
GZ-GRA-s0.2-32	PCR Rotor, GRA-s0.2-32 for PCR strips, 4-rows	32 x 0.2 ml
Adaptors for mini		
GZ-GAS-m0.2(2)	0.2 ml Adaptor	0.2 ml/ea
GZ-GAS-m0.5(2)	0.5 ml Adaptor	0.5 ml/ea

Multi-Purpose Centrifuges 1236MR

GZ-1236MG	1236MG, Multi-purpose Centrifuge without Rotor (220V, 50/60Hz)	
Rotors for 1236MG		
GZ-GRS-r250-4-1236	Swing Rotor, GRS-r250-4-1236	4 x 250 ml
GZ-GRS-c250-4-1236	Swing Rotor, GRS-c250-4-1236	4 x 250 ml
GZ-GRS-b85-6-1236	Swing Rotor, GRS-b85-6-1236 (for Biosafety)	6 x 85 ml
GZ-GRF-m2.0-24-1236	Fixed Angle Rotor, GRF-m2.0-24-1236 with lid	24 x 1.5/2.0 ml
GZ-GRF-m2.0-30-1236	Fixed Angle Rotor, GRF-m2.0-30-1236 with lid	30 x 1.5/2.0 ml
GZ-GRF-85-6-1236	Fixed Angle Rotor, GRF-85-6-1236 with lid	6 x 85 ml
GZ-GRA-15-24-1236	Angle rotor, GRA-15-24-1236 includes 24 Steel Sleeves, GLB-15-FA	24 x 15 ml
Steel Sleeve, Microplate Holder, and Buckets for 1236MG		
GZ-GLB-15-FA	Steel Sleeves, GLB-15-FA	15 ml/1ea
GZ-GLB-r250-r250	Rectangular Bucket, GLB-r250, for Rotor GRS-r250-4-1236	250 ml/1ea
GZ-GLB-b85-b85	85 ml Bucket for Rotor, GRS-b85-6-1236 (for Biosafety)	85 ml/1ea
GZ-GLP-mw-r250	Microplate Holder, GLP-mw, for Rotor GRS-r250-4-1236	96 P
GZ-GLB-c250-c250	Conical Bucket, GLB-c250, for Rotor GRS-c250-4-1236	250 ml/1ea
GZ-GBL-b85-b85a	Bucket Cap for Bucket GLB-b85-b85 (for Biosafety), autoclavable	
Adaptors for 1236MG		
GZ-GAS-m0.2(2)	0.2 ml Adaptor	0.2 ml/1ea
GZ-GAS-m0.5(2)	0.5 ml Adaptor	0.5 ml/1ea
GZ-GAS-3(15)	3 ml Adaptor for Sleeve GLB-15-FA	3 ml/1ea
GZ-GAS-4(15)	4 ml Adaptor for Sleeve GLB-15-FA	4 ml/1ea
GZ-GAS-5(15)	5 ml Adaptor for Sleeve GLB-15-FA	5 ml/1ea
GZ-GAS-15(85)	15 ml Adaptor for Rotor GRF-85-6-1236	15 ml/1ea
GZ-GAS-c15(85)	15 ml Conical Adaptor for Rotor GRF-85-6-1236	15 ml conical/1ea
GZ-GAS-50(85)	50 ml Adaptor for Rotor GRF-85-6-1236	50 ml/1ea
GZ-GAS-c50(85)	50 ml Conical Adaptor for Rotor GRF-85-6-1236	50 ml conical/1ea
Tube Racks for 1236MG		
GZ-GAM-5-12	Tube Rack, GAM-5-12 for Bucket, GLB-r250	12 x 3 or 5 ml/1ea
GZ-GAM-15-12	Tube Rack, GAM-15-12 for Bucket, GLB-r250	12 x 10 or 15 ml/1ea
GZ-GAM-c15-9	Tube Rack, GAM-c15-9 for Bucket, GLB-r250	9 x 15 ml conical/1ea
GZ-GAM-50-4	Tube Rack, GAM-50-4 for Bucket, GLB-r250	4 x 50 ml/1ea
GZ-GAM-c50-3	Tube Rack, GAM-c50-3 for Bucket, GLB-r250	3 x 50 ml conical/1ea
GZ-GAM-85-2	Tube Rack, GAM85-2 for Bucket, GLB-r250	2 x 85 & 15 ml/1ea
GZ-GAS-250(r250)	Tube Rack, GAS-250(r250) for Bucket, GLB-r250	1 x 250 ml/1ea

Multi-Purpose Centrifuges 1236MGR

GZ-1236MGR	1236MGR, Multi-purpose Centrifuge without Rotor (220V, 50/60Hz)	
Rotors for 1236MGR		
GZ-GRS-r250-4-1236R	Swing Rotor, GRS-r250-4-1236R	4 x 250 ml
GZ-GRS-c250-4-1236R	Swing Rotor, GRS-c250-4-1236R	4 x 250 ml
GZ-GRS-b85-6-1236R	Swing Rotor, GRS-b85-6-1236R (for Biosafety)	6 x 85 ml
GZ-GRF-m2.0-24-1236R	Fixed Angle Rotor, GRF-m2.0-24-1236R with lid	24 x 1.5/2.0 ml
GZ-GRF-m2.0-30-1236R	Fixed Angle Rotor, GRF-m2.0-30-1236R with lid	30 x 1.5/2.0 ml
GZ-GRF-15-24-1236R	Fixed Angle Rotor, GRF-15-24-1236R with lid	24 x 15 ml
GZ-GRF-50-8-1236R	Fixed Angle Rotor, GRF-50-8-1236R with lid	8 x 50 ml
GZ-GRF-85-6-1236R	Fixed Angle Rotor, GRF-85-6-1236R with lid	6 x 85 ml
GZ-GRA-15-24-1236R	Angle rotor, GRA-15-24 includes 24 Steel Sleeves, GLB-15-FA	24 x 15 ml

Steel Sleeve, Microplate Holder, and Buckets for 1236MGR		
GZ-GLB-15-FA	Steel Sleeves, GLB-15-FA	15 ml/1ea
GZ-GLB-r250-r250	Rectangular Bucket, GLB-r250, for Rotor GRS-r250-4-1236R	250 ml/1ea
GZ-GLB-b85-b85	85 ml Bucket for Rotor, GRS-b85-6-1236R (for Biosafety)	85 ml/1ea
GZ-GLP-mw-r250	Microplate Holder, GLP-mw, for Rotor GRS-r250-4-1236R	96 P
GZ-GLB-c250-c250	Conical Bucket, GLB-c250, for Rotor GRS-c250-4-1236R	250 ml/1ea
GZ-GBL-b85-b85a	Bucket Cap for Bucket GLB-b85-b85 (for Biosafety), autoclavable	
Adaptors for 1236MGR		
GZ-GAS-m0.2(2)	0.2 ml Adaptor	0.2 ml/1ea
GZ-GAS-m0.5(2)	0.5 ml Adaptor	0.5 ml/1ea
GZ-GAS-3(15)	3 ml Adaptor for Sleeve GLB-15-FA	3 ml/1ea
GZ-GAS-4(15)	4 ml Adaptor for Sleeve GLB-15-FA	4 ml/1ea
GZ-GAS-5(15)	5 ml Adaptor for Sleeve GLB-15-FA	5 ml/1ea
GZ-GAS-15(50)	15ml Adaptor for Rotor GRF-50-8-1236R	15 ml/1ea
GZ-GAS-c15(50)	15ml Conical Adaptor for Rotor GRF-50-8-1236R	15 ml conical/1ea
GZ-GAS-15(85)	15 ml Adaptor for Rotor GRF-85-6-1236R	15 ml/1ea
GZ-GAS-c15(85)	15 ml Conical Adaptor for Rotor GRF-85-6-1236R	15 ml conical/1ea
GZ-GAS-50(85)	50 ml Adaptor for Rotor GRF-85-6-1236R	50 ml/1ea
GZ-GAS-c50(85)	50 ml Conical Adaptor for Rotor GRF-85-6-1236R	50 ml conical/1ea
Tube Racks for 1236MGR		
GZ-GAM-5-12	Tube Rack, GAM-5-12 for Bucket, GLB-r250	12 x 3 or 5 ml/1ea
GZ-GAM-15-12	Tube Rack, GAM-15-12 for Bucket, GLB-r250	12 x 10 or 15 ml/1ea
GZ-GAM-c15-9	Tube Rack, GAM-c15-9 for Bucket, GLB-r250	9 x 15 ml conical/1ea
GZ-GAM-50-4	Tube Rack, GAM-50-4 for Bucket, GLB-r250	4 x 50 ml/1ea
GZ-GAM-c50-3	Tube Rack, GAM-c50-3 for Bucket, GLB-r250	3 x 50 ml conical/1ea
GZ-GAM-85-2	Tube Rack, GAM85-2 for Bucket, GLB-r250	2 x 85 & 15 ml/1ea
GZ-GAS-250(r250)	Tube Rack, GAS-250(r250) for Bucket, GLB-r250	1 x 250 ml/1ea

Multi-Purpose Centrifuges 1580MG

GZ-1580MG	1580MG, Multi-purpose Centrifuge without Rotor (220V, 50/60Hz)	
Rotors for 1580MG		
GZ-GRS-r250-4-1580	Swing Rotor, GRS-r250-4-1580	4 x 250 ml
GZ-GRS-r750-4-1580	Swing Rotor, GRS-r750-4-1580	4 x 750 ml
GZ-GRS-750-4-1580	Swing Rotor, GRS-750-4-1580	4 x 750 ml
GZ-GRS-b85-6-1580	Swing Rotor, GRS-b85-6-1580 (for Biosafety)	6 x 85 ml
GZ-GRF-m2.0-24-1580	Fixed Angle Rotor, GRF-m2.0-24-1580 with lid	24 x 1.5/2.0 ml
GZ-GRF-m2.0-30-1580	Fixed Angle Rotor, GRF-m2.0-30-1580 with lid	30 x 1.5/2.0 ml
GZ-GRF-50-8-1580	Fixed Angle Rotor, GRF-50-8-1580 with lid	8 x 50 ml
GZ-GRF-85-6-1580R	Fixed Angle Rotor, GRF-85-6-1580 with lid	6 x 85 ml
GZ-GRF-250-6-1580	Fixed Angle Rotor, GRF-250-6-1580 with lid	6 x 250 ml
GZ-GRA-15-24-1580	Angle rotor, GRA-15-24 includes 24 Steel Sleeves, GLB-15-FA	24 x 15 ml
Steel Sleeve, Microplate Holders, & Buckets for 1580MG		
GZ-GLB-15-FA	Steel Sleeve, GLB-15-FA	15 ml/1ea
GZ-GLB-r250-r250	Rectangular bucket, GLB-r250, for Rotor GRS-r250-4-1580	250 ml/1ea
GZ-GLP-mw-r250	Microplate Holder, GLP-mw, for Rotor GRS-r250-4-1580	96 P
GZ-GLB-r750-r750	Rectangular bucket, GLB-r750, for Rotor GRS-r750-4-1580	750 ml/1ea
GZ-GLB-500-r750	Round bucket, GLB-500, for Rotor GRS-r750-4-1580	500 ml/1ea
GZ-GLB-400-r750	Round bucket, GLB-400, for Rotor GRS-r750-4-1580	4 blood bags
GZ-GLP-mw-r750	Microplate Holder, GLP-mw, for Rotor GRS-r750-4-1580	96 P
GZ-GLB-750-750	Round bucket, GLB-750, for Rotor GRS-750-4-1580	750 ml/1ea
GZ-GLB-b750-750	Round bucket, GLB-b750, for Rotor GRS-750-4-1580 (for Biosafety)	750 ml/1ea
GZ-GLB-500-750	Round bucket, GLB-500, for Rotor GRS-750-4-1580	500 ml/1ea
GZ-GLB-400-750	Round bucket, GLB-400, for Rotor GRS-750-4-1580	4 blood bags
GZ-GLP-mw-750	Microplate Holder, GLP-mw, for Rotor GRS-750-4-1580	96 P
GZ-GLB-b85-b85	85 ml Bucket for Rotor, GRS-b85-6-1580 (for Biosafety)	85 ml/1ea
GZ-GBL-b750-750	Bucket Cap for Bucket GLB-b750 (for Biosafety)	
GZ-GBL-b750-750a	Bucket Cap for Bucket GLB-b750 (for Biosafety), autoclavable	
GZ-GBL-b85-b85a	Bucket Cap for Bucket GLB-b85-b85 (for Biosafety), autoclavable	

Adaptors for 1580MG		
GZ-GAS-m0.2(2)	0.2 ml Adaptor	0.2 ml/1ea
GZ-GAS-m0.5(2)	0.5 ml Adaptor	0.5 ml/1ea
GZ-GAS-3(15)	3 ml Adaptor for Sleeve GLB-15-FA	3 ml/1ea
GZ-GAS-4(15)	4 ml Adaptor for Sleeve GLB-15-FA	4 ml/1ea
GZ-GAS-5(15)	5 ml Adaptor for Sleeve GLB-15-FA	5 ml/1ea
GZ-GAS-15(50)	15 ml Adaptor for Rotor GRF-50-8-1580	15 ml/1ea
GZ-GAS-c15(50)	15 ml Conical Adaptor for Rotor GRF-50-8-1580	15 ml conical/1ea
GZ-GAS-15(85)	15 ml Adaptor for Rotor GRF-85-6-1580	15 ml/1ea
GZ-GAS-c15(85)	15 ml Conical Adaptor for Rotor GRF-85-6-1580	15 ml conical/1ea
GZ-GAS-50(85)	50 ml Adaptor for Rotor GRF-85-6-1580	50 ml/1ea
GZ-GAS-c50(85)	50 ml Conical Adaptor for Rotor GRF-85-6-1580	50 ml conical/1ea
Tube Racks for 1580MG		
GZ-GAM-5-12	Tube Rack, GAM-5-12 for Bucket, GLB-r250	12 x 3 or 5 ml/1ea
GZ-GAM-15-12	Tube Rack, GAM-15-12 for Bucket, GLB-r250	12 x 10 or 15 ml/1ea
GZ-GAM-c15-9	Tube Rack, GAM-c15-9 for Bucket, GLB-r250	9 x 15 ml conical/1ea
GZ-GAM-50-4	Tube Rack, GAM-50-4 for Bucket, GLB-r250	4 x 50 ml/1ea
GZ-GAM-c50-3	Tube Rack, GAM-c50-3 for Bucket, GLB-r250	3 x 50 ml conical/1ea
GZ-GAM-85-2	Tube Rack, GAM-85-2 for Bucket, GLB-r250	2 x 85 & 15 ml/1ea
GZ-GAS-250(r250)	Tube Rack, GAS-250(r250) for Bucket, GLB-r250	1 x 250 ml/1ea
GZ-GAM-5-30	Tube Rack, GAM-5-30 for Bucket, GLB-r750	30 x 3 or 5 ml/1ea
GZ-GAM-15-20	Tube Rack, GAM-15-20 for Bucket, GLB-r750	20 x 10 or 15 ml/1ea
GZ-GAM-c15-16	Tube Rack, GAM-c15-16 for Bucket, GLB-r750	16 x 15 ml conical/1ea
GZ-GAM-50-8	Tube Rack, GAM-50-8 for Bucket, GLB-r750	8 x 50 ml/1ea
GZ-GAM-c50-r5	Tube Rack, GAM-c50-5 for Bucket, GLB-r750	5 x 50 ml conical/1ea
GZ-GAS-250(r750)	Tube Rack, GAS-250(r750) for Bucket, GLB-r750	1 x 250 ml/1ea
GZ-GAM-5-24	Tube Rack, GAM-5-24 for Bucket GLB-750 & b750	24 x 3 or 5 ml/1ea
GZ-GAM-15-19	Tube Rack, GAM-15-19 for Bucket GLB-750 & b750	19 x 15 ml/1ea
GZ-GAM-10-21	Tube Rack, GAM-10-21 for Bucket GLB-750 & b750	21 x 10 ml/1ea
GZ-GAM-c15-14	Tube Rack, GAM-c15-14 for Bucket GLB-750 & b750	14 x 15 ml conical/1ea
GZ-GAM-50-7	Tube Rack, GAM-50-7 for Bucket GLB-750 & b750	7 x 50 ml/1ea
GZ-GAM-c50-5	Tube Rack, GAM-c50-5 for Bucket GLB-750 & b750	5 x 50 ml conical/1ea
GZ-GAS-250(750)	Tube Rack, GAS-250(750) for Bucket GLB-750 & b750	1 x 250 ml/1ea

Multi-Purpose Centrifuges 1580MGR

GZ-1580MGR	1580MGR, Multi-purpose Centrifuge without Rotor (220V, 50/60Hz)	
Rotors for 1580MGR		
GZ-GRS-r250-4-1580R	Swing Rotor, GRS-r250-4-1580R	4 x 250 ml
GZ-GRS-r750-4-1580R	Swing Rotor, GRS-r750-4-1580R	4 x 750 ml
GZ-GRS-750-4-1580R	Swing Rotor, GRS-750-4-1580R	4 x 750 ml
GZ-GRS-b85-6-1580R	Swing Rotor, GRS-b85-6-1580R (for Biosafety)	6 x 85 ml
GZ-GRF-m2.0-24-1580R	Fixed Angle Rotor, GRF-m2.0-24-1580R with lid	24 x 1.5/2.0 ml
GZ-GRF-m2.0-30-1580R	Fixed Angle Rotor, GRF-m2.0-30-1580R with lid	30 x 1.5/2.0 ml
GZ-GRF-50-8-1580R	Fixed Angle Rotor, GRF-50-8-1580R with lid	8 x 50 ml
GZ-GRF-85-6-1580R	Fixed Angle Rotor, GRF-85-6-1580R with lid	6 x 85 ml
GZ-GRF-250-6-1580R	Fixed Angle Rotor, GRF-250-6-1580R with lid	6 x 250 ml
GZ-GRA-15-24-1580R	Angle rotor, GRA-15-24 includes 24 Steel Sleeves, GLB-15-FA	24 x 15 ml
Steel Sleeve, Microplate Holders, & Buckets for 1580MGR		
GZ-GLB-15-FA	Steel Sleeve, GLB-15-FA	15 ml/1ea
GZ-GLB-r250-r250	Rectangular bucket, GLB-r250, for Rotor GRS-r250-4-1580R	250 ml/1ea
GZ-GLP-mw-r250	Microplate Holder, GLP-mw, for Rotor GRS-r250-4-1580R	96 P
GZ-GLB-r750-r750	Rectangular bucket, GLB-r750, for Rotor GRS-r750-4-1580R	750 ml/1ea
GZ-GLB-500-r750	Round bucket, GLB-500, for Rotor GRS-r750-4-1580R	500 ml/1ea
GZ-GLB-400-r750	Round bucket, GLB-400, for Rotor GRS-r750-4-1580R	4 blood bags
GZ-GLP-mw-r750	Microplate Holder, GLP-mw, for Rotor GRS-r750-4-1580R	96 P
GZ-GLB-750-750	Round bucket, GLB-750, for Rotor GRS-750-4-1580R	750 ml/1ea
GZ-GLB-b750-750	Round bucket, GLB-b750, for Rotor GRS-750-4-1580R (for Biosafety)	750 ml/1ea
GZ-GLB-500-750	Round bucket, GLB-500, for Rotor GRS-750-4-1580R	500 ml/1ea
GZ-GLB-400-750	Round bucket, GLB-400, for Rotor GRS-750-4-1580R	4 blood bags
GZ-GLP-mw-750	Microplate Holder, GLP-mw, for Rotor GRS-750-4-1580R	96 P
GZ-GLB-b85-b85	85 ml Bucket for Rotor, GRS-b85-6-1580R (for Biosafety)	85 ml/1ea
GZ-GBL-b750-750	Bucket Cap for Bucket GLB-b750 (for Biosafety)	
GZ-GBL-b750-750a	Bucket Cap for Bucket GLB-b750 (for Biosafety), autoclavable	
GZ-GBL-b85-b85a	Bucket Cap for Bucket GLB-b85-b85 (for Biosafety), autoclavable	

Adaptors for 1580MGR		
GZ-GAS-m0.2(2)	0.2 ml Adaptor	0.2 ml/1ea
GZ-GAS-m0.5(2)	0.5 ml Adaptor	0.5 ml/1ea
GZ-GAS-3(15)	3 ml Adaptor for Sleeve GLB-15-FA	3 ml/1ea
GZ-GAS-4(15)	4 ml Adaptor for Sleeve GLB-15-FA	4 ml/1ea
GZ-GAS-5(15)	5 ml Adaptor for Sleeve GLB-15-FA	5 ml/1ea
GZ-GAS-15(50)	15 ml Adaptor for Rotor GRF-50-8-1580R	15 ml/1ea
GZ-GAS-c15(50)	15 ml Conical Adaptor for Rotor GRF-50-8-1580R	15 ml conical/1ea
GZ-GAS-15(85)	15 ml Adaptor for Rotor GRF-85-6-1580R	15 ml/1ea
GZ-GAS-c15(85)	15 ml Conical Adaptor for Rotor GRF-85-6-1580R	15 ml conical/1ea
GZ-GAS-50(85)	50 ml Adaptor for Rotor GRF-85-6-1580R	50 ml/1ea
GZ-GAS-c50(85)	50 ml Conical Adaptor for Rotor GRF-85-6-1580R	50 ml conical/1ea
Tube Racks for 1580MGR		
GZ-GAM-5-12	Tube Rack, GAM-5-12 for Bucket, GLB-r250	12 x 3 or 5 ml/1ea
GZ-GAM-15-12	Tube Rack, GAM-15-12 for Bucket, GLB-r250	12 x 10 or 15 ml/1ea
GZ-GAM-c15-9	Tube Rack, GAM-c15-9 for Bucket, GLB-r250	9 x 15 ml conical/1ea
GZ-GAM-50-4	Tube Rack, GAM-50-4 for Bucket, GLB-r250	4 x 50 ml/1ea
GZ-GAM-c50-3	Tube Rack, GAM-c50-3 for Bucket, GLB-r250	3 x 50 ml conical/1ea
GZ-GAM-85-2	Tube Rack, GAM-85-2 for Bucket, GLB-r250	2 x 85 & 15 ml/1ea
GZ-GAS-250(r250)	Tube Rack, GAS-250(r250) for Bucket, GLB-r250	1 x 250 ml/1ea
GZ-GAM-5-30	Tube Rack, GAM-5-30 for Bucket, GLB-r750	30 x 3 or 5 ml/1ea
GZ-GAM-15-20	Tube Rack, GAM-15-20 for Bucket, GLB-r750	20 x 10 or 15 ml/1ea
GZ-GAM-c15-16	Tube Rack, GAM-c15-16 for Bucket, GLB-r750	16 x 15 ml conical/1ea
GZ-GAM-50-8	Tube Rack, GAM-50-8 for Bucket, GLB-r750	8 x 50 ml/1ea
GZ-GAM-c50-r5	Tube Rack, GAM-c50-5 for Bucket, GLB-r750	5 x 50 ml conical/1ea
GZ-GAS-250(r750)	Tube Rack, GAS-250(r750) for Bucket, GLB-r750	1 x 250 ml/1ea
GZ-GAM-5-24	Tube Rack, GAM-5-24 for Bucket GLB-750 & b750	24 x 3 or 5 ml/1ea
GZ-GAM-15-19	Tube Rack, GAM-15-19 for Bucket GLB-750 & b750	19 x 15 ml/1ea
GZ-GAM-10-21	Tube Rack, GAM-10-21 for Bucket GLB-750 & b750	21 x 10 ml/1ea
GZ-GAM-c15-14	Tube Rack, GAM-c15-14 for Bucket GLB-750 & b750	14 x 15 ml conical/1ea
GZ-GAM-50-7	Tube Rack, GAM-50-7 for Bucket GLB-750 & b750	7 x 50 ml/1ea
GZ-GAM-c50-5	Tube Rack, GAM-c50-5 for Bucket GLB-750 & b750	5 x 50 ml conical/1ea
GZ-GAS-250(750)	Tube Rack, GAS-250(750) for Bucket GLB-750 & b750	1 x 250 ml/1ea

Multi-Purpose Centrifuges 1736MGR

GZ-1736MGR	1736MGR, Multi-purpose Centrifuge without Rotor (220V, 50/60Hz)	
Rotors for 1736MGR		
GZ-GRS-r250-4-1736R	Swing Rotor, GRS-r250-4-1736R	4 x 250 ml
GZ-GRF-m2.0-24-1736R	Fixed Angle Rotor, GRF-m2.0-24-1736R with lid	24 x 1.5/2.0 ml
GZ-GRF-m2.0-30-1736R	Fixed Angle Rotor, GRF-m2.0-30-1736R with lid	30 x 1.5/2.0 ml
GZ-GRF-50-6-1736R	Fixed Angle Rotor, GRF-50-6-1736R with lid	6 x 50 ml
GZ-GRF-c50-6-1736R	Fixed Angle Rotor, GRF-c50-6-1736R with lid	6 x 50 ml conical
GZ-GRF-50-8-1736R	Fixed Angle Rotor, GRF-50-8-1736R with lid	8 x 50 ml
GZ-GRF-85-6-1736R	Fixed Angle Rotor, GRF-85-6-1736R with lid	6 x 85 ml
GZ-GRF-250-6-1736R	Fixed Angle Rotor, GRF-250-6-1736R with lid	6 x 250 ml
Microplate Holder & Bucket for 1736MGR		
GZ-GLB-r250-r250	Rectangular Bucket, GLB-r250, for Rotor GRS-r250-4-1736R	250 ml/1ea
GZ-GLP-mw-r250	Microplate Holder for Rotor GRS-r250-4-1736R	96 P
Adaptors for 1736MGR		
GZ-GAS-m0.2(2)	0.2 ml Adaptor	0.2 ml/1ea
GZ-GAS-m0.5(2)	0.5 ml Adaptor	0.5 ml/1ea
GZ-GAS-15(50)	15 ml Adaptor for Rotor GRF-50-6-1736R & GRF-50-8-1736R	15 ml/1ea
GZ-GAS-c15(50)	15 ml Conical Adaptor for Rotor GRF-50-6-1736R & GRF-50-8-1736R	15 ml conical/1ea
GZ-GAS-15(85)	15 ml Adaptor for Rotor GRF-85-6-1736R	15 ml/1ea
GZ-GAS-c15(85)	15 ml Conical Adaptor for Rotor GRF-85-6-1736R	15 ml conical/1ea

GZ-GAS-50(85)	50 ml Adaptor for Rotor GRF-85-6-1736R	50 ml/1ea
GZ-GAS-c50(85)	50 ml Conical Adaptor for Rotor GRF-85-6-1736R	50 ml conical/1ea
Tube Racks for 1736MGR		
GZ-GAM-5-12	Tube Rack, GAM-5-12 for Bucket, GLB-r250	12 x 3 or 5 ml
GZ-GAM-15-12	Tube Rack, GAM-15-12 for Bucket, GLB-r250	12 x 10 or 15 ml
GZ-GAM-c15-9	Tube Rack, GAM-c15-9 for Bucket, GLB-r250	9 x 15 ml conical
GZ-GAM-50-4	Tube Rack, GAM-50-4 for Bucket, GLB-r250	4 x 50 ml
GZ-GAM-c50-3	Tube Rack, GAM-c50-3 for Bucket, GLB-r250	3 x 50 ml conical
GZ-GAM-85-2	Tube Rack, GAM-85-2 for Bucket, GLB-r250	2 x 85 & 15 ml
GZ-GAS-250(r250)	Tube Rack, GAS-250 (r250) for Bucket, GLB-r250	1 x 250 ml

Refrigerators

4°C BLOOD BANK REFRIGERATORS

Catalogue No.	Model	Description
H-HXC-106	HXC-106	106 Liters, 160W, Ambient Temp 10°C~32°C
H-HXC-158	HXC-158	158 Liters, 350W, Ambient Temp 10°C~32°C
H-HXC-258	HXC-258	258 Liters, Ambient Temp 10°C~43°C
H-HXC-358	HXC-358	358 Liters, 460W, Ambient Temp 10°C~32°C
H-HXC-608	HXC-608	608 Liters, 490W, Ambient Temp 10°C~32°C
H-HXC-936	HXC-936	936 Liters, 930W, Ambient Temp 10°C~32°C

2-8°C PHARMACY REFRIGERATORS

Catalogue No.	Model	Description
H-HYC-68	HYC-68	68 Litres, 84W, Ambient Temp 10°C~32°C, Single layer glass, Upright
H-HYC-260	HYC-260	260 Litres, 220W, Ambient Temp 10°C~32°C, Single layer glass, Upright
H-HYC-360	HYC-360	360 Litres, 310W, Ambient Temp 10°C~32°C, Single layer glass, Upright
H-HYC-610	HYC-610	610 Litres, 490W, Ambient Temp 10°C~32°C, Single layer glass, Upright
H-HYC-940	HYC-940	940 Litres, 940W, Ambient Temp 10°C~32°C, double layer glass, Upright

2-8°C ICE-LINED REFRIGERATORS

Catalogue No.	Model	Description
H-HBC-70	HBC-70	70 Litres, 140W, Temp. set range 2°C~8°C, 2 Baskets
H-HBC-200	HBC-200	200 Litres, 210W, Temp. set range 2°C~8°C, 3 Baskets

FREEZER

-25°C DEEP FREEZER

Catalogue No.	Model	Description
H-HBD-116	HBD-116	116 Litres, 140W, Temp. set range -15°C~ -25°C, 1 Basket
H-HBD-286	HBD-286	286 Litres, 200W, Temp. set range -15°C~ -25°C, 2 Baskets

-40°C DEEP FREEZER

Catalogue No.	Model	Description
H-DW-40W100	DW-40W100	100 Litres, 260W, Temp.range -20°C~-40°C, Chest
H-DW-40W255	DW-40W255	255 Litres, 410W, Temp.range -20°C~-40°C, Chest
H-DW-40W380	DW-40W380	380 Litres, 550W, Temp.range -20°C~-40°C, Chest
H-DW-40L92	DW-40L92	92 Litres, 260W, Temp.range -20°C~-40°C, Upright
H-DW-40L188	DW-40L188	188 Litres, 290W, Temp.range -10°C~-40°C, Upright
H-DW-40L262	DW-40L262	262 Litres, 400W, Temp.range -10°C~-40°C, Upright
H-DW-40L626	DW-40L626	626 Litres, 700W, Temp.range -10°C~-40°C, Upright

-60°C DEEP FREEZER

Catalogue No.	Model	Description
H-DW-50W255	DW-50W255	255 Litres, 520W, Temp.range -30°C~-60°C, Chest

Catalogue No.	Model	Description
H-HYCD-282	HYCD-282	192 Litres, 220W, Temp.range -2°C~ 8°C, Upright

-86°C ULT FREEZER

Catalogue No.	Model	Description
H-DW-86W420	DW-86W420	420 Litres, Chest, Temp.range -40°C~-86°C, Chest
H-DW-86L288	DW-86L288	288 Litres, Upright, Temp.range -40°C~-86°C, Upright
H-DW-86L388	DW-86L388	388 Litres, Upright, Temp.range -40°C~-86°C, Upright
H-DW-86L628	DW-86L628	628 Litres, Upright, Temp.range -40°C~-86°C, Upright

-150°C ULT FREEZER

Catalogue No.	Model	Description
H-DW-150W200	DW-150W200	Cryo Freezer -150°C, 380V, 200 Litres,Temp.range -126°C--150°C, Chest

MEDICAL WASHER- DISINFECTOR

Catalogue No.	Model	Description
H-HRQX-180	HRQX-180	180 Litres, 380V, 2Layers adjustable washing shelves, 4sets basket
H-HRQX-280	HRQX-280	280 Litres, 380V,4Layers adjustable washing shelves, 8sets basket
H-HRQX-380	HRQX-380	380 Litres, 380V,1Layers adjustable washing shelves, 2sets basket
H-HRQX-480	HRQX-480	480 Litres, 380V,5Layers adjustable washing shelves, 2sets basket

THERMO CYCLER

H-HR-PCR-96G	HR-PCR-96G	220V,Sample Capacity: 96x0.2ml+77x0.5ml, Block Temp.Range: 4°C - 99.9°C
--------------	-------------------	---

OPTIONAL ACCESSORIES

Catalogue No.	Description
H-RACK-L	Storage rack for DW-86L286/386/626
H-RACK-W	Storage rack for DW-86W310/420
H-BOX	Storage box for ULT freezer
H-CHART	Circular chart temperature recorder
H-PRINTER	Printer temperature recorder
H-CO2	CO2 backup system (Please note that client has to supply CO2)
H-NITROGEN	Liquid nitrogen backup system

Bottletop Dispenser

Ceramus - Classic (Ceramic Piston)

Catalogue No.	Description
9310000	0.2 - 1ml - Increment : 0.05ml
9320000	0.4 - 2ml - Increment : 0.05ml
9330000	1 - 5ml - Increment : 0.10ml
9340000	2 - 10ml - Increment : 0.25ml
9350000	5 - 30ml - Increment : 0.50ml
9360000	10 - 60ml - Increment : 1.00ml

Ceramus- Classic FIX Volume (Ceramic Piston)

9311100	1ml
9321100	2ml
9331100	5ml
9341100	10ml
9351100	25ml
9361100	50ml

Ceramus (Ceramic Piston, with reagent recirculation system)

9312000	0.2 - 1ml - Increment : 0.05ml
9322000	0.4 - 2ml - Increment : 0.05ml
9332000	1 - 5ml - Increment : 0.10ml
9342000	2 - 10ml - Increment : 0.25ml
9352000	5 - 30ml - Increment : 0.50ml
9362000	10 - 60ml - Increment : 1.00ml

Ceramus FIX Volume (Ceramic Piston, with reagent recirculation system)

9312100	1ml
9322100	2ml
9332100	5ml
9342100	10ml
9352100	25ml
9362100	50ml

EM-Dispenser PP (Glass piston)

9340200	2 - 10ml - Increment : 0.25ml
9360200	10 - 60ml - Increment : 1.00ml

Ceramus, HF

9342300	2 - 10ml - Increment : 0.25ml
---------	-------------------------------

Pipetting Apparatus

Pipetus Akku

Catalogue No.	Description
9907800	Rechargeable Pipette Filler for All Pipetter from 0.1 up to 200ml

Pipetus-Junior

9902000	From 0.5ml, Manually Operated
---------	-------------------------------

Pipetus-standard

9903010	0.1 - 100ml, complete with electric pump, 2 filters& 1 safety valve extra
9904010	0.1 - 100ml, Electric pipette filler for any usual pipette

9905600	Wall Holder
9905700	Table Stand

PUMPS

Catalogue No.	Model	Description
KNF-N86KN.18	N86KN.18	PPS Pump Head, EPDM Diaphragm, FPM Valves, 6 l/min Delivery , 100mbar abs Ultimate vacuum
KNF-N86KT.18	N86KT.18	PPS Pump Head, PTFE-Coated Diaphragm, FFPM Valves, 5.5 l/min Delivery , 160mbar abs Ultimate vacuum
KNF-N811KN.18	N811KN.18	PPS Pump Head, EPDM Diaphragm, FPM Valves, 11.5 l/min Delivery, 240mbar abs Ultimate vacuum
KNF-N811KT.18	N811KT.18	PPS Pump Head, PTFE-Coated Diaphragm, FFPM Valves, 11.5 l/min Delivery, 290mbar abs Ultimate vacuum
KNF-N816.3KN.18	N816.3KN.18	PPS Pump Head, EPDM Diaphragm, EPDM Valves, 16 l/min 16 l/min Delivery , 15mbar abs Ultimate vacuum
KNF-N816.3KT.18	N816.3KT.18	PPS Pump Head, PTFE-coated Diaphragm, FFPM Valves, 16 l/min Delivery , 20mbar abs Ultimate vacuum
KNF-N816.1.2KT.18	N816.1.2KT.18	PPS Pump Head, PTFE-coated Diaphragm, FFPM Valves, 30 l/min Delivery , 160mbar abs Ultimate vacuum
KNF-N816.1.2KN.18	N816.1.2KN.18	PPS Pump Head, EPDM-coated Diaphragm, EPDM Valves, 30 l/min Delivery , 160mbar abs Ultimate vacuum
KNF-N820.3AT.18	N820.3AT.18	Aluminium Pump Head, PTFE-coated Diaphragm, FFPM Valves, 20 l/min Delivery , 8mbar abs Ultimate vacuum
KNF-N810FT.18	N810FT.18	PTFE Head, PTFE-Coated Diaphragm, FFPM Valves, 10 l/min Delivery , 100mbar abs Ultimate vacuum
KNF-N820FT.18	N820FT.18	PTFE Head, PTFE-Coated Diaphragm, FFPM Valves, 20 l/min Delivery , 100mbar abs Ultimate vacuum
KNF-N820AT.18	N820AT.18	PTFE Head, PTFE-Coated Diaphragm, FFPM Valves, 22 l/min Delivery , 100mbar abs Ultimate vacuum
KNF-N820AN.18	N820AN.18	PTFE Head, PTFE-Coated Diaphragm, FFPM Valves, 22 l/min Delivery , 100mbar abs Ultimate vacuum
KNF-N840FT.18	N840FT.18	PTFE Head, PTFE-Coated Diaphragm, FFPM Valves, 34 l/min Delivery , 100mbar abs Ultimate vacuum
KNF-N840.3FT.40.18	N840.3FT.40.18	PTFE Head, PTFE-Coated Diaphragm, FFPM Valves, 34 l/min Delivery , 10mbar abs Ultimate vacuum
KNF-N842.3FT.18	N842.3FT.18	PTFE Pump Head, PTFE-coated Diaphragm, FFPM Valves, 34 l/min Delivery , 2mbar abs Ultimate vacuum
KNF-N920AP.29.18	N920AP.29.18	Aluminium Head, EPDM Diaphragm, EPDM Valves, Max 21 l/min Delivery , 1.5mbar abs Ultimate vacuum
KNF-N920KT.29.18	N920KT.29.18	PPS Head, PTFE-coated Diaphragm, FFPM Valves, Max 20 l/min Delivery , 2mbar abs Ultimate vacuum
KNF-SC920	SC920	Max 20 l/min Delivery , 2mbar abs Ultimate vacuum Dimensions (mm) H x W x D: 423 x 366 x 294
KNF-048459		Modular Vacuum systems, controlled vacuum 048459
KNF-N840.1.2FT.18	N840.1.2FT.18	PTFE Head, PTFE-Coated Diaphragm, FFPM Valves, 60 l/min Delivery , 90mbar abs Ultimate vacuum
KNF-N820.3FT.40.18	N820.3FT.40.18	PTFE Head, PTFE-Coated Diaphragm, FFPM Valves, 20 l/min Delivery , 10mbar abs Ultimate vacuum
KNF-N840.3FT.18	N840.3FT.18	PTFE Pump Head, PTFE-coated Diaphragm, FFPM Valves, 34 l/min Delivery , 8mbar abs Ultimate vacuum
KNF-N820.3FT.18	N820.3FT.18	PTFE Pump Head, PTFE-coated Diaphragm, FFPM Valves, 20 l/min Delivery , 8mbar abs Ultimate vacuum
KNF-N810.3FT.18	N810.3FT.18	PTFE Pump Head, PTFE-coated Diaphragm, FFPM Valves, 10 l/min Delivery , 8mbar abs Ultimate vacuum
KNF-N820.3AN.18	N820.3AN.18	Aluminium Head, CR Diaphragm, NBR Valves, 22 l/min Delivery , 8mbar abs Ultimate vacuum
KNF-N816.1.2KT.45.18	N816.1.2KT.45.18	PPS Pump Head, PTFE-coated Diaphragm, FFPM Valves, 30 l/min Delivery , 160mbar abs Ultimate vacuum
KNF-N816.3KT.45.18	N816.3KT.45.18	PPS Pump Head, PTFE-coated Diaphragm, FFPM Valves, 30 l/min Delivery , 160mbar abs Ultimate vacuum
KNF-N816.3KN.45.18	N816.3KN.45.18	PPS Pump Head, EPDM Diaphragm, EPDM Valves, 30 l/min Delivery , 160mbar abs Ultimate vacuum
KNF-N816.1.2KN.45.18	N816.1.2KN.45.18	PPS Pump Head, PTFE-coated Diaphragm, FFPM Valves, 30 l/min Delivery , 100mbar abs Ultimate vacuum

Ultrasonic Cleaners

SK Series

35kHz Low Frequency, Non-Heating, Timer 1-99min

Catalogue No.	Model	Description
SK2200	SK2200	3 Litres, Ultrasonic Power 100W
SK3300	SK3300	6 Litres, Ultrasonic Power 180W
SK5200	SK5200	10 Litres, Ultrasonic Power 200W
SK250	SK250	10 Litres, Ultrasonic Power 250W
SK7200	SK7200	15 Litres, Ultrasonic Power 350W
SK8200	SK8200	22.5 Litres, Ultrasonic Power 500W

SK-HP Series

53kHz High Frequency, Power Adjustable 40-100%, Non-Heating, Timer 1-199min

Catalogue No.	Model	Description
SK2200HP	SK2200HP	3 Litres, Ultrasonic Power 90W
SK3200HP	SK3200HP	4.5 Litres, Ultrasonic Power 135W
SK3300HP	SK3300HP	6 Litres, Ultrasonic Power 160W
SK5200HP	SK5200HP	10 Litres, Ultrasonic Power 200W
SK250HP	SK250HP	10 Litres, Ultrasonic Power 250W
SK6200HP	SK6200HP	10.5 Litres, Ultrasonic Power 280W
SK7200HP	SK7200HP	15 Litres, Ultrasonic Power 350W
SK8200HP	SK8200HP	22.5 Litres, Ultrasonic Power 500W

SK-GT Series

53kHz High Frequency, Temperature 20°C to 60°C, Timer 1-99min, With Degas Function

Catalogue No.	Model	Description
SK03GT	SK03GT	3 Litres, Ultrasonic Power 100W, Heater Power 75W, Degas Power 100W
SK06GT	SK06GT	6 Litres, Ultrasonic Power 180W, Heater Power 150W, Degas Power 180W
SK10GT	SK10GT	10 Litres, Ultrasonic Power 200W, Heater Power 270W, Degas Power 200W
SK14GT	SK14GT	14 Litres, Ultrasonic Power 250W, Heater Power 345W, Degas Power 250W
SK15GT	SK15GT	15 Litres, Ultrasonic Power 350W, Heater Power 390W, Degas Power 350W
SK20GT	SK20GT	22.5 Litres, Ultrasonic Power 500W, Heater Power 520W, Degas Power 500W
SK30GT	SK30GT	30 Litres, Ultrasonic Power 600W, Heater Power 630W, Degas Power 600W

LABWIT, CHINA

SHAKING INCUBATOR

Multi-amplitude Orbital Constant Temp. Shaking Incubator

Catalogue No.	Model	Description
ZC-ZHWY-100B	ZHWY-100B	Temp. Range Ambient 5-60°C, Speed 30-400rpm, 540W
ZC-ZHWY-200B	ZHWY-200B	Temp. Range Ambient 4-60°C, Speed 30-400rpm, 700W
ZC-ZHWY-103B	ZHWY-103B	Temp. Range Ambient 5-60°C, Speed 30-400rpm, 280W
ZC-ZHWY-103D	ZHWY-103D	Temp. Range Ambient 5-60°C, Speed 30-600rpm, 280W
ZC-ZHWY-100D	ZHWY-100D	Temp. Range Ambient 5-60°C, Speed 30-600rpm, 540W
ZC-ZHWY-200D	ZHWY-200D	Temp. Range Ambient 4-60°C, Speed 30-600rpm, 700W
ZC-ZHWY-100F	ZHWY-100F	Temp. Range Ambient 5-60°C, Speed 30-600rpm, 540W

Horizontal Constant Temp. Shaking Incubator

ZC-ZHWY-211B	ZHWY-211B	Temp. Range Ambient 4-60°C, Speed 30-300rpm, 6940W
ZC-ZHWY-111B	ZHWY-111B	Temp. Range Ambient 5-60°C, Speed 30-300rpm, 680W
ZC-ZHWY-211C	ZHWY-211C	Temp. Range Ambient 54-60°C, Speed 30-300rpm, 1120W
ZC-ZHWY-111C	ZHWY-111C	Temp. Range Ambient 5-60°C, Speed 30-300rpm, 830W
ZC-ZHWY-211D	ZHWY-211D	Temp. Range Ambient 4-60°C, Speed 30-300rpm, 1340W
ZC-ZHWY-111D	ZHWY-111D	Temp. Range Ambient 5-60°C, Speed 30-300rpm, 960W
ZC-ZHWY-211F	ZHWY-211F	Temp. Range Ambient 4-60°C, Speed 30-300rpm, 1380W
ZC-ZHWY-111F	ZHWY-111F	Temp. Range Ambient 5-60°C, Speed 30-300rpm, 110W

Double Layer Constant Temp. Shaking Incubator

ZC-ZHWY-2102C	ZHWY-2102C	Single Door, Temp. Range Ambient 4-60°C, Speed 30-300rpm, 830W
ZC-ZHWY-1102C	ZHWY-1102C	Single Door, Temp. Range Ambient 5-60°C, Speed 30-300rpm, 600W
ZC-ZHWY-2102	ZHWY-2102	Double Doors, Temp. Range Ambient 4-60°C, Speed 30-300rpm, 1200W
ZC-ZHWY-1102	ZHWY-1102	Double Doors, Temp. Range Ambient 5-60°C, Speed 30-300rpm, 930W
ZC-ZHWY-2112B	ZHWY-2112B	Double Doors, Temp. Range Ambient 4-60°C, Speed 30-300rpm, 1420W
ZC-ZHWY-1112B	ZHWY-1112B	Double Doors, Temp. Range Ambient 5-60°C, Speed 30-300rpm, 1150W
ZC-ZHWY-2112C	ZHWY-2112C	Temp. Range Ambient 4-60°C, Speed 30-300rpm, 1200W
ZC-ZHWY-1112C	ZHWY-1112C	Temp. Range Ambient 5-60°C, Speed 30-300rpm, 1150W
ZC-ZHWY-2112F	ZHWY-2112F	Double Doors, Temp. Range Ambient 4-60°C, Speed 30-300rpm, 1420W
ZC-ZHWY-1112F	ZHWY-1112F	Double Doors, Temp. Range Ambient 5-60°C, Speed 30-300rpm, 1150W

Multifunctional De-staining Benchtop Platform Shaker

ZC-ZHWY-304	ZHWY-304	Temp. Range Ambient 5-50°C, Speed 30-300rpm, 25W
ZC-ZHWY-334	ZHWY-334	Temp. Range Ambient 5-50°C, Speed 30-300rpm, 25W
ZC-ZHWY-354	ZHWY-354	Temp. Range Ambient 5-50°C, Speed 20-80rpm, 25W
ZC-ZHWY-344	ZHWY-344	Temp. Range Ambient 5-50°C, Speed 20-80rpm, 25W

Shakers

ZC-ZHWY-3112	ZHWY-3112	Temp. Range Ambient 5-50°C, Speed 30-300rpm, 400W
ZC-ZHWY-311	ZHWY-311	Temp. Range Ambient 5-50°C, Speed 30-300rpm, 400W
ZC-ZHWY-3222	ZHWY-3222	Temp. Range Ambient 5-50°C, Speed 30-300rpm, 400W
ZC-ZHWY-3212	ZHWY-3212	Temp. Range Ambient 5-50°C, Speed 30-300rpm, 400W
ZC-ZHWY-322	ZHWY-322	Temp. Range Ambient 5-50°C, Speed 30-300rpm, 400W
ZC-ZHWY-3312	ZHWY-3312	Temp. Range Ambient 5-50°C, Speed 30-300rpm, 400W
ZC-ZHWY-331	ZHWY-331	Temp. Range Ambient 5-50°C, Speed 30-300rpm, 400W

Reciprocating Water Bath Shaking Incubator

ZC-ZHWY-110X30	ZHWY-110X30	Speed Range 20-180rpm, 1600W
ZC-ZHWY-110X50	ZHWY-110X50	Speed Range 20-180rpm, 1600W

LABWIT, CHINA

SHAKING INCUBATOR

Multifunctional Intelligent composite shaking incubator

Catalogue No.	Model	Description
ZC-ZHWY-A211C	ZHWY-A211C	Temp. Range 4-60°C, Speed 30-300rpm, 1120W
ZC-ZHWY-A211D	ZHWY-A211D	Temp. Range 4-60°C, Speed 30-300rpm, 1340W
ZC-ZHWY-A211F	ZHWY-A211F	Temp. Range 4-60°C, Speed 30-300rpm, 1380W
ZC-ZHWY-A2102	ZHWY-A2102	Temp. Range 4-60°C, Speed 30-300rpm, 1200W
ZC-ZHWY-A2102C	ZHWY-A2102C	Temp. Range 4-60°C, Speed 30-300rpm, 1200W
ZC-ZHWY-A2112B	ZHWY-A2112B	Temp. Range 4-60°C, Speed 30-300rpm, 1420W
ZC-ZHWY-A2112F	ZHWY-A2112F	Temp. Range 4-60°C, Speed 30-300rpm, 1420W
ZC-ZHWY-B211C	ZHWY-B211C	Temp. Range 4-60°C, Speed 30-300rpm, 1120W
ZC-ZHWY-B211D	ZHWY-B211D	Temp. Range 4-60°C, Speed 30-300rpm, 1340W
ZC-ZHWY-B211F	ZHWY-B211F	Temp. Range 4-60°C, Speed 30-300rpm, 1380W
ZC-ZHWY-B2102	ZHWY-B2102	Temp. Range 4-60°C, Speed 30-300rpm, 1200W
ZC-ZHWY-B2102C	ZHWY-B2102C	Temp. Range 4-60°C, Speed 30-300rpm, 1200W
ZC-ZHWY-B2112B	ZHWY-B2112B	Temp. Range 4-60°C, Speed 30-300rpm, 1420W
ZC-ZHWY-B2112F	ZHWY-B2112F	Temp. Range 4-60°C, Speed 30-300rpm, 1420W
ZC-ZHWY-C211C	ZHWY-C211C	Temp. Range 4-60°C, Speed 30-300rpm, 1200W
ZC-ZHWY-C211D	ZHWY-C211D	Temp. Range 4-60°C, Speed 30-300rpm, 1380W
ZC-ZHWY-C211F	ZHWY-C211F	Temp. Range 4-60°C, Speed 30-300rpm, 1420W
ZC-ZHWY-C2102	ZHWY-C2102	Temp. Range 4-60°C, Speed 30-300rpm, 1200W
ZC-ZHWY-C2112B	ZHWY-C2112B	Temp. Range 4-60°C, Speed 30-300rpm, 1420W
ZC-ZHWY-C2112F	ZHWY-C2112F	Temp. Range 4-60°C, Speed 30-300rpm, 1420W

CLEAN BENCH

Intelligent Safety Clean Benches B Series

Catalogue No.	Model	Description
ZC-ZHJH-C1106B	ZHJH-C1106B	Clean Benches, 380W, Single-sided Work Surface
ZC-ZHJH-C1109B	ZHJH-C1109B	Clean Benches, 380W, Single-sided Work Surface
ZC-ZHJH-C1112B	ZHJH-C1112B	Clean Benches, 680W, Single-sided Work Surface
ZC-ZHJH-C1115B	ZHJH-C1115B	Clean Benches, 680W, Single-sided Work Surface
ZC-ZHJH-C1118B	ZHJH-C1118B	Clean Benches, 680W, Single-sided Work Surface
ZC-ZHJH-C1209B	ZHJH-C1209B	Clean Benches, 380W, Double-sided Work Surface
ZC-ZHJH-C1214B	ZHJH-C1214B	Clean Benches, 680W, Double-sided Work Surface
ZC-ZHJH-C2109B	ZHJH-C2109B	Clean Benches, 380W, Single-sided Work Surface
ZC-ZHJH-C2112B	ZHJH-C2112B	Clean Benches, 680W, Single-sided Work Surface

Intelligent Safety Clean Benches C Series (Digital)

Catalogue No.	Model	Description
ZC-ZHJH-C1106C	ZHJH-C1106C	Clean Benches, 380W, Single-sided Work Surface
ZC-ZHJH-C1109C	ZHJH-C1109C	Clean Benches, 380W, Single-sided Work Surface
ZC-ZHJH-C1112C	ZHJH-C1112C	Clean Benches, 680W, Single-sided Work Surface
ZC-ZHJH-C1115C	ZHJH-C1115C	Clean Benches, 680W, Single-sided Work Surface
ZC-ZHJH-C1118C	ZHJH-C1118C	Clean Benches, 680W, Single-sided Work Surface
ZC-ZHJH-C1209C	ZHJH-C1209C	Clean Benches, 380W, Double-sided Work Surface
ZC-ZHJH-C1214C	ZHJH-C1214C	Clean Benches, 680W, Double-sided Work Surface
ZC-ZHJH-C2109C	ZHJH-C2109C	Clean Benches, 380W, Single-sided Work Surface
ZC-ZHJH-C2112C	ZHJH-C2112C	Clean Benches, 680W, Single-sided Work Surface

LABWIT, CHINA

SAFETY CABINET

Intelligent Biological Safety Cabinet

Catalogue No.	Model	Description
ZC-ZSA-273L1	ZSA-273L1	Temp. Range 10-30°C, 550W
ZC-ZSA-274L1	ZSA-274L1	Temp. Range 10-30°C, 950W
ZC-ZSA-275L1	ZSA-275L1	Temp. Range 10-30°C, 1000W
ZC-ZSA-276L1	ZSA-276L1	Temp. Range 10-30°C, 1100W
ZC-ZSB-203L1	ZSB-203L1	Temp. Range 10-30°C, 1100W
ZC-ZSB-204L1	ZSB-204L1	Temp. Range 10-30°C, 1150W
ZC-ZSB-205L1	ZSB-205L1	Temp. Range 10-30°C, 1400W
ZC-ZSB-206L1	ZSB-206L1	Temp. Range 10-30°C, 1800W

Liquid Bath

Catalogue No.	Model	Description
ZC-ZSQ-3	ZSQ-3	3 Liter,Temp Ambient ~100°C, 1000W
ZC-ZSQ-10	ZSQ-10	10 Liter,Temp Ambient ~200°C, 2000W
ZC-ZSBB-712	ZSBB-712	6.5 Liter,Temp Ambient ~100°C, 500W
ZC-ZSBB-724	ZSBB-724	13 Liter,Temp Ambient ~100°C, 1000W
ZC-ZSBB-726	ZSBB-726	20 Liter,Temp Ambient ~100°C, 1500W
ZC-ZSBB-728	ZSBB-728	26.5 Liter,Temp Ambient ~100°C, 2000W
ZC-ZSXH-618	ZSXH-618	18 Liter,Temp Ambient ~65°C, 1500W
ZC-ZSXH-625	ZSXH-625	25 Liter,Temp Ambient ~65°C, 2000W

Basic Peristaltic Pump

Catalogue No.	Description	Pump Head
	Drive Type	
LP-BQ50-1J-WX10-14	BQ50-1J	WX10-14, Flow rate: 0.0002 - 20 ml/min
LP-BT50-1J- DG-110	BT50-1J	DG-1(10 Rollers)
LP-BT100-2J-YZ1515X	BT100-2J	YZ1515X
LP-BT100-2J-YZII15		YZII15
LP-BT100-2J-YZ2515X		YZ2515X
LP-BT100-2J-YZII25		YZII25
LP-BT100-2J- DG-106		DG-1(6 Rollers)
LP-BT100-2J- DG-110		DG-1(10 Rollers)
LP-BT100-2J- DG-206		DG-2(6 Rollers)
LP-BT100-2J- DG-210		DG-2(10 Rollers)
LP-BT300-2J-YZ1515X	BT300-2J	YZ1515X
LP-BT300-2J-YZII15		YZII15
LP-BT300-2J-YZ2515X		YZ2515X
LP-BT300-2J-YZII25		YZII25
LP-BT300-2J-BZ25		BZ25
LP-BT600-2J-YZ1515X	BT600-2J	YZ1515X
LP-BT600-2J-YZII15		YZII15
LP-BT600-2J-YZ2515X		YZ2515X
LP-BT600-2J-YZII25		YZII25
LP-BT600-2J-BZ25		BZ25
LP-WT600-2J-YZ1515X	WT600-2J	YZ1515X
LP-WT600-2J-YZII15		YZII15
LP-WT600-2J-YZ2515X		YZ2515X
LP-WT600-2J-YZII25		YZII25
LP-WT600-2J-KZ25		KZ25
LP-WT600-2J-2YZ1515X		2xYZ1515X
LP-WT600-2J-2YZII15		2xYZII15
LP-WT600-2J-2YZ2515X		2xYZ2515X
LP-WT600-2J-Masterflex07018-20		Masterflex07018 - 20
LP-WT600-2J-Masterflex07035-20		Masterflex07035 - 20
LP-WT600-2J-DG15-24		DG15-24
LP-WT600-2J-DMD25		DMD25

Flow Rates Peristaltic Pump

Catalogue No.	Description	Pump Head
	Drive Type	
LP-BT100-1L- DG-406	BT100-1L	DG-4(6rollers)
LP-BT100-1L- DG-410		DG-4(10rollers)
LP-BT100-1L- DG-606		DG-6(6rollers)
LP-BT100-1L- DG-610		DG-6 (10rollers)
LP-BT100-1L- DG-806		DG-8(6rollers)
LP-BT100-1L- DG-810		DG-8(10rollers)
LP-BT100-1L- DG-1206		DG-12(6rollers)
LP-BT100-1L- DG-1210		DG-12(10rollers)
LP-BT100-1L- DG-1606		DG-16(6rollers)
LP-BT100-1L- DG-1610		DG-16(10rollers)
LP-BT100-1L- DG-2406		DG-24(6rollers)
LP-BT100-1L- DG-2410		DG-24(10rollers)
LP-BT100-1L- YZ1515X		YZ1515X
LP-BT100-1L- YZII15		YZII15
LP-BT100-1L- YZ2515X		YZ2515X
LP-BT100-1L- YZII25		YZII25
LP-BT100-1L- 2YZ1515X		2xYZ1515X
LP-BT100-1L- 2YZII15		2xYZII15
LP-BT100-1L- 2 YZ2515X		2xYZ2515X

LP-BT100-1L- 2YZII25	BT100-1L	2xYZII25
LP-BT100-1L- 3YZ1515X		3xYZ1515X
LP-BT100-1L- 3YZII15		3xYZII15
LP-BT100-1L- 3YZ2515X		3xYZ2515X
LP-BT100-1L- 4YZ1515X		4xYZ1515X
LP-BT100-1L- 4YZII15		4xYZII15
LP-BT100-1L- 4YZ2515X		4xYZ2515X
LP-BT100-1L- DG15-24		DG15-24
LP-BT100-1L- DG15-28		DG15-28
LP-BT100-1L- DG15-48		DG15-48

LP-LEAD-2-LEAD15-24	LEAD-2	LEAD15-24
LP-LEAD-2-LEAD15-44		LEAD15-44
LP-LEAD-2-LEAD15-48		LEAD15-48
LP-LEAD-2-LEAD15-88		LEAD15-88

Dispensing Peristaltic Pump

LP-BT100-1F-YZ1515X	BT100-1F	YZ1515X
LP-BT100-1F-YZII15		YZII15
LP-BT100-1F-YZ2515X		YZ2515X
LP-BT100-1F-YZII25		YZII25
LP-BT100-1F-DG-106		DG-1(6rollers)
LP-BT100-1F-DG-110		DG-1(10rollers)
LP-BT100-1F-DG-206		DG-2(6rollers)
LP-BT100-1F-DG-210		DG-2(10rollers)
LP-BT100-1F-DG-406		DG-4(6rollers)
LP-BT100-1F-DG-410		DG-4(10rollers)

LP-BT300-1F-YZ1515X	BT300-1F	YZ1515X
LP-BT300-1F-YZII15		YZII15
LP-BT300-1F-YZ2515X		YZ2515X
LP-BT300-1F-YZII25		YZII25

Accessories

LP-DispenserFK-1C		FK-1C
LP-FootswitchJK-1		JK-1 (DB-9) for peristaltic pump
LP-FootswitchJK-2		JK-2 for dispensing controller
LP-FootswitchJK-3		JK-3 (DB-15) for peristaltic pump
LP-ControllerSK-BQ50		Hand-held Remote controller BQ50-1J only
LP-FixedPlate		For BQ50-1J only
LP-StandardInterface		0 - 5V analog input 0 - 10V analog input 4 - 20mA current input Pulse frequency input

Pump Head

LP-YZ1515X	Pump Head	YZ1515X, Suitable Tubing : 13#14#16#19#25#17#18#
LP-YZII15		YZII15, Suitable Tubing : 13#14#16#19#25#17#18#
LP-YZ2515X		YZ2515X, Suitable Tubing : 15#24#
LP-YZII25		YZII25, Suitable Tubing : 15#24#
LP-DMD25		DMD25, Suitable Tubing : 15#24#35#36#
LP-DG-106		DG-1 (6), Suitable Tubing : W.T.:0.8- 1mm I.D.≤3.17 mm
LP-DG-110		DG-1 (10), Suitable Tubing : W.T.:0.8- 1mm I.D.≤3.17 mm
LP-DG-206		DG-2 (6), Suitable Tubing : W.T.:0.8- 1mm I.D.≤3.17 mm
LP-DG-210		DG-2 (10), Suitable Tubing : W.T.:0.8- 1mm I.D.≤3.17 mm
LP-DG-406		DG-4 (6), Suitable Tubing : W.T.:0.8- 1mm I.D.≤3.17 mm
LP-DG-410		DG-4 (10), Suitable Tubing : W.T.:0.8- 1mm I.D.≤3.17 mm
LP-DG-606		DG-6 (6), Suitable Tubing : W.T.:0.8- 1mm I.D.≤3.17 mm
LP-DG-610		DG-6 (10), Suitable Tubing : W.T.:0.8- 1mm I.D.≤3.17 mm
LP-DG-806		DG-8 (6), Suitable Tubing : W.T.:0.8- 1mm I.D.≤3.17 mm
LP-DG-810		DG-8 (10), Suitable Tubing : W.T.:0.8- 1mm I.D.≤3.17 mm
LP-DG-1206		DG-12 (6), Suitable Tubing : W.T.:0.8- 1mm I.D.≤3.17 mm
LP-DG-1210		DG-12 (10), Suitable Tubing : W.T.:0.8- 1mm I.D.≤3.17 mm
LP-DG15-24	Pump Head	DG-15-24, Suitable Tubing : 16#25#17#
LP-DG15-28		DG-15-28, Suitable Tubing : W.T.:0.8- 1mm I.D.≤3.17 mm, 13#, 14

LP-DG15-48	Pump Head	DG-15-48, Suitable Tubing : W.T.:0.8- 1mm I.D.≤3.17 mm, 13#, 14#
LP-KZ25		KZ25, Suitable Tubing : 15#24#35#36#
LP-BZ25		BZ25, Suitable Tubing : 24#
LP-YZ35-13		YZ35-13, Suitable Tubing : 73#82#
LP-YZ35-POM		YZ35 (POM), Suitable Tubing : 73#82#
MP-YZ35-AI		YZ35 (AI), Suitable Tubing : 73#82#

Silicone Tubing

Catalogue No.	Description	
	Drive Type	Pump Head
LP-ST13	13#	Inner Diameter 0.8mm, Wall Thickness 1.6mm YZ1515 YZ II 15 TH15 DG15-28(48)
LP-ST14	14#	Inner Diameter 1.6mm, Wall Thickness 1.6mm YZ1515 YZ II 15 TH15 DG15-28(48)
LP-ST19	19#	Inner Diameter 2.4mm, Wall Thickness 1.6mm YZ1515 YZ II 15 TH15
LP-ST16	16#	Inner Diameter 3.1mm, Wall Thickness 1.6mm YZ1515 YZ II 15 DG15-24 TH15
LP-ST25	25#	Inner Diameter 4.8mm, Wall Thickness 1.6mm YZ1515 YZ II 15 DG15-24 TH15
LP-ST17	17#	Inner Diameter 6.4mm, Wall Thickness 1.6mm YZ1515 YZ II 15 DG15-24
LP-ST18	18#	Inner Diameter 7.9mm, Wall Thickness 1.6mm YZ1515 YZ II 15
LP-ST15	15#	Inner Diameter 4.8mm, Wall Thickness 2.5mm YZ2515 YZ II 25 KZ25
LP-ST24	24#	Inner Diameter 6.4mm, Wall Thickness 2.5mm YZ2515 YZ II 25 BZ25 KZ25
LP-ST35	35#	Inner Diameter 7.9mm, Wall Thickness 2.5mm KZ25 YZ II 25
LP-ST36	36#	Inner Diameter 9.6mm, Wall Thickness 2.5mm KZ25 YZ II 25
LP-ST73	73#	Inner Diameter 9.5mm, Wall Thickness 3.3mm YZ35 BZ35
LP-ST82	82#	Inner Diameter 12.7mm, Wall Thickness 3.3mm YZ35
LP-ST86	86#	Inner Diameter 9.5mm, Wall Thickness 6.3mm KZ48/63
LP-ST88	88#	Inner Diameter 12.7mm, Wall Thickness 4.7mm KZ48/63
LP-ST90	90#	Inner Diameter 19mm, Wall Thickness 6.35mm KZ48/63
LP-ST92	92#	Inner Diameter 25.4mm, Wall Thickness 4.76mm KZ48/63
LP-ST05X08	0.5×0.8	Inner Diameter 0.5mm, Wall Thickness 0.8mm DG JY10 WX10 DG15-28(48)
LP-ST1X1	1×1	Inner Diameter 1mm, Wall Thickness 1mm DG JY10 WX10 DG15-28(48)
LP-ST2X1	2×1	Inner Diameter 2mm, Wall Thickness 1mm DG JY10 WX10 DG15-28(48)
LP-ST24X08	2.4×0.8	Inner Diameter 2.4mm, Wall Thickness 0.8mm DG JY10 WX10 DG15-28(48)
LP-ST3X1	3×1	Inner Diameter 3mm, Wall Thickness 1mm DG JY10 WX10 DG15-28(48)
LP-ST1X1SSS	1×1sss	Inner Diameter 1mm, Wall Thickness 1mm DG
LP-ST2X1SSS	2×1sss	Inner Diameter 2mm, Wall Thickness 1mm DG
LP-ST24X08SSS	2.4×0.8sss	Inner Diameter 2.4mm, Wall Thickness 0.8mm DG

PURIS, Expe- Water Systems

PURIS, Expe-RO Water Systems

Catalogue No.	
M-XRE18EPM	Expe-RO Ele10 , Flow Rate up to 10L/Hr
M-XRE28EPM	Expe-RO Ele 20 , Flow Rate up to 20L/ Hr
M-XRE38EPM	Expe-RO Edi 15

PURIS, Expe-UP Water Systems

Catalogue No.	
M-XUEB8EPM	Expe-UP Ele , Flow Rate up to 1.5L/Min
M-XUEV8EPM	Expe-UP Ele UV , Flow Rate up to 1.5L/Min
M-XUEF8EPM	Expe-UP Ele UF, Flow Rate up to 1.0L/Min
M-XUEVF8EPM	Expe-UP Ele UV/UF, Flow Rate up to 1.0L/Min

PURIS, Expe-CB Water Systems

Catalogue No.	
M-XRUE18EPM	Expe-CB Ele10 , Flow rate: For RO 10L/hr, for UP 1,5L/min
M-XRUE28EPM	Expe-CB Ele 20 , Flow rate: For RO: 20L/hr, for UP: 1,5L/min
M-XRUE38EPM	Expe-CB Ele UV

Accessories

For RO Water Systems

Catalogue No.	
M-FXPC265M	Expe-PC Pack
M-FXRM075M	Expe-RO Membrane I
M-FXRM275M	Expe-RO Membrane II
M-FXRT035M	35Litre Reservoir Tank, with Level Sensor
M-FXPD801M	Printer with interface for data output

Accessories

For UP Water Systems

Catalogue No.	
M-FXCI265M	Expe-CI Pack
M-FXMI265M	Expe-MI Pack
M-FXDL014M	UV Lamp (185+254nm)
M-FXUM100M	UF Membrane (MW10,000)
M-ASMF02-BM	Final Filter, 0.2um

Accessories

For CB Water Systems

Catalogue No.	
M-FXPC265M	Expe-PC Pack
M-FXRM075M	Expe-RO Membrane I
M-FXRM275M	Expe-RO Membrane II
M-FXC1265M	Expe-CI Pack
M-FXDL014M	UV Lamp (185+254nm)
M-ASMF02-BM	Final Filter, 0.2µm

Oven

Catalogue No.	Model	Description	UOM	Brand
MC000683	Ecocell 55	Oven With Natural Air Convection, Ambient +5°C to 250°C, 55Litre	unit	MMM/ GERMANY
MC000690	Ecocell 111	Oven With Natural Air Convection, Ambient +5°C to 250°C, 111Litre	unit	MMM/ GERMANY
MC000712	Venticell 55	Oven With Forced Air Convection, Ambient +10°C to 250°C, 55Litre	unit	MMM/ GERMANY
MC000714	Venticell 111	Oven With Forced Air Convection, Ambient +10°C to 250°C, 111Litre	unit	MMM/ GERMANY
MC000716	Venticell 222	Oven With Forced Air Convection, Ambient +10°C to 250°C, 222Litre	unit	MMM/ GERMANY
MC000718	Venticell 404	Oven With Forced Air Convection, Ambient +10°C to 250°C, 404Litre	unit	MMM/ GERMANY
MC000720	Venticell 707	Oven With Forced Air Convection, Ambient +10°C to 250°C, 707Litre	unit	MMM/ GERMANY
MC000713	Venticell 55	Oven With Forced Air Convection, Ambient +10°C to 300°C, 55Litre	unit	MMM/ GERMANY
MC000715	Venticell 111	Oven With Forced Air Convection, Ambient +10°C to 300°C, 111Litre	unit	MMM/ GERMANY
MC000799	Stericell 55	Oven With Sterilising Purpose, Ambient +10°C to 250°C, 55Litre	unit	MMM/ GERMANY
MC000750	Stericell 111	Oven With Sterilising Purpose, Ambient +10°C to 250°C, 111Litre	unit	MMM/ GERMANY
MC000922	Vacucell 22	Vacuum Oven, Ambient +10°C to 200°C, 22Litre	unit	MMM/ GERMANY
MC000924	Vacucell 55	Vacuum Oven, Ambient +10°C to 200°C, 55Litre	unit	MMM/ GERMANY

Incubator

Catalogue No.	Model	Description	UOM	Brand
MC000722	IncuCell 55	Incubator With Natural Forced Air Convection, Ambient +5°C to 70°C, 55Litre	unit	MMM/ GERMANY
MC000724	IncuCell 111	Incubator With Natural Forced Air Convection, Ambient +5°C to 70°C, 111Litre	unit	MMM/ GERMANY
MC000726	IncuCell 222	Incubator With Natural Forced Air Convection, Ambient +5°C to 70°C, 222Litre	unit	MMM/ GERMANY
MC000728	IncuCell 404	Incubator With Natural Forced Air Convection, Ambient +5°C to 70°C, 404Litre	unit	MMM/ GERMANY
MC000730	IncuCell 707	Incubator With Natural Forced Air Convection, Ambient +5°C to 70°C, 707Litre	unit	MMM/ GERMANY
MC000684	IncuCell V 55	Incubator With Natural Forced Air Convection, Ambient +10°C to 70°C, 55Litre	unit	MMM/ GERMANY
MC000691	IncuCell V 111	Incubator With Natural Forced Air Convection, Ambient +10°C to 70°C, 111Litre	unit	MMM/ GERMANY
MC000921	Friocell 55	Cool Incubator With Forced Air Convection, +0°C to 99.9°C, 55Litre	unit	MMM/ GERMANY
MC000923	Friocell 111	Cool Incubator With Forced Air Convection, +0°C to 99.9°C, 111Litre	unit	MMM/ GERMANY
MC000925	Friocell 222	Cool Incubator With Forced Air Convection, +0°C to 99.9°C, 222Litre	unit	MMM/ GERMANY
MC000928	Friocell 404	Cool Incubator With Forced Air Convection, +0°C to 99.9°C, 404Litre	unit	MMM/ GERMANY
MC000927	Friocell 707	Cool Incubator With Forced Air Convection, +0°C to 99.9°C, 707Litre	unit	MMM/ GERMANY
MC001610	Climacell 111	Incubator With Forced Air Convection, Cooling & Controlled Humidity, without humidity 0.0 °C up to 99.9 °C,with humidity: 10 °C up to 90.0 °C, 111Litre	unit	MMM/ GERMANY
MC001620	Climacell 222	Incubator With Forced Air Convection, Cooling & Controlled Humidity, without humidity 0.0 °C up to 99.9 °C,with humidity: 10 °C up to 90.0 °C, 222Litre	unit	MMM/ GERMANY
MC001630	Climacell 404	Incubator With Forced Air Convection, Cooling & Controlled Humidity, without humidity 0.0 °C up to 99.9 °C,with humidity: 10 °C up to 90.0 °C, 404Litre	unit	MMM/ GERMANY
MC001640	Climacell 707	Incubator With Forced Air Convection, Cooling & Controlled Humidity, without humidity 0.0 °C up to 99.9 °C,with humidity: 10 °C up to 90.0 °C, 707Litre	unit	MMM/ GERMANY
MC001425	CO2CELL 48 STANDARD	CO2 Incubator- Atmosphaera, Ambient +1°C to 50°C, 48Litre	unit	MMM/ GERMANY
MC001416	CO2CELL 170 STANDARD	CO2 Incubator- Atmosphaera, Ambient +1°C to 50°C, 170Litre	unit	MMM/ GERMANY
MC001420	CO2CELL 48 COMFORT	CO2 Incubator- Atmosphaera, Ambient +1°C to 50°C, 48Litre	unit	MMM/ GERMANY
MC001414	CO2CELL 170 COMFORT	CO2 Incubator- Atmosphaera, Ambient +1°C to 50°C, 170Litre	unit	MMM/ GERMANY

Catalogue No.	Model	Description	UOM	Brand
TI167300-22	Rocker 300	Oil-Free Vacuum Pump Max. Vacuum : -650mmHg=85.5kPa=110torr Max Flow:17 l/min Horse Power : 1/8 HP	unit	ROCKER SCIENTIFIC / TAIWAN
TI167400-22	Rocker 400	Oil-Free Vacuum Pump Max. Vacuum : -650mmHg=85.5kPa=110torr Max Flow:34 l/min Horse Power : 1/6 HP	unit	ROCKER SCIENTIFIC / TAIWAN
TI167410-22	Rocker 410	Oil-Free Vacuum Pump Max. Vacuum : -750mmHg=99.99Pa=110torr Max Flow:19 l/min Horse Power : 1/6 HP	unit	ROCKER SCIENTIFIC / TAIWAN
TI167600-22	Rocker 600	Oil-Free Vacuum Pump Max. Vacuum : -650mmHg=85.5kPa=110torr Max Flow:58 l/min Horse Power : 1/4 HP	unit	ROCKER SCIENTIFIC / TAIWAN
TI167610-22	Rocker 610	Oil-Free Vacuum Pump Max. Vacuum : -750mmHg=99.9kPa=110torr Max Flow:33 l/min Horse Power : 1/4 HP	unit	ROCKER SCIENTIFIC / TAIWAN
TI167330-00	Rocker 300DC	DC Power Vacuum Pump Max. Vacuum : -650mmHg=85.5kPa=110torr Max Flow:24 l/min Horse Power : 1/8 HP	unit	ROCKER SCIENTIFIC / TAIWAN
TI167320-22	Rocker 320	Oil-Free Compressor Max. Pressure (wt. moisture trap) : 100psi Max. Pressure (w. moisture trap) : 80psi Max Flow:12 l/min	unit	ROCKER SCIENTIFIC / TAIWAN
TI167420-22	Rocker 420	Oil-Free Compressor Max. Pressure (wt. moisture trap) : 100psi Max. Pressure (w. moisture trap) : 80psi Max Flow:25 l/min	unit	ROCKER SCIENTIFIC / TAIWAN
TI167620-22	Rocker 620	Compressor	unit	ROCKER SCIENTIFIC / TAIWAN
TI167440-22	Rocker 440	Compressed Air Supply System Max. Pressure : 60psi , Max Flow:25 l/min	unit	ROCKER SCIENTIFIC / TAIWAN
TI167225-22	BioVac 225	BioVac 225 Suction System Standard Includes: * Suction Bottle 1000ml - 1 unit * Fuse - 2 units * Single Channel Aspiration Adapter - 1 unit * 0.2µm x 37mm Disc Filter - 2 units * Silicone Tubing 100cm - 1 unit	unit	ROCKER SCIENTIFIC / TAIWAN
TI167240-22	BioVac 240	BioVac 240 Suction System Standard Includes: * Suction Bottle 2000ml - 1 unit * Fuse - 2 units * Single Channel Aspiration Adapter - 1 unit * 0.2µm x 37mm Disc Filter - 2 units * Silicone Tubing 100cm - 1 unit * Foot switch	unit	ROCKER SCIENTIFIC / TAIWAN

TI175200-22	Galaxy 230	Colony Counter Readout : 4 Digit (0 - 9999) Bright Red 0.6" LED Display Petri Dish Size : 90 - 150mm Diameter Dimension : 313 x 360 x 346mm (WxHxD) c/w Marking Pen (Black) 1pc	unit	ROCKER SCIENTIFIC / TAIWAN
TI175300-22	Galaxy 230	Colony Counter with PC Software Readout : 4 Digit (0 - 9999) Bright Red 0.6" LED Display Petri Dish Size : 90 - 150mm Diameter Dimension : 313 x 360 x 346mm (WxHxD) c/w Marking Pen (Black) 1pc	unit	ROCKER SCIENTIFIC / TAIWAN
175300-12		PC software	unit	ROCKER SCIENTIFIC /
175300-15		RS232 to USB (XP,Vista) adapter cable	unit	ROCKER SCIENTIFIC /
175200-48		Marking Pen Set	unit	ROCKER SCIENTIFIC /
175200-35		Marking Pen	unit	ROCKER SCIENTIFIC /
TI170210-22	DRY60	Electronic Dry Cabinet , 68 Litres External : 400 x 410 x 560mm (WxDxH) Internal : 398 x 355 x 480mm (WxDxH) Shelf : 2	unit	ROCKER SCIENTIFIC / TAIWAN
TI170211-22	DRY70	Electronic Dry Cabinet , 88 Litres External : 400 x 410 x 660mm (WxDxH) Internal : 398 x 355 x 580mm (WxDxH) Shelf : 2	unit	ROCKER SCIENTIFIC / TAIWAN
TI170212-22	DRY100	Electronic Dry Cabinet , 116 Litres External : 400 x 410 x 890mm (WxDxH) Internal : 398 x 355 x 820mm (WxDxH) Shelf : 3	unit	ROCKER SCIENTIFIC / TAIWAN
TI170213-22	DRY120	Electronic Dry Cabinet , 116 Litres External : 806 x 410 x 480mm (WxDxH) Internal : 804 x 355 x 405mm (WxDxH) Shelf : 2	unit	ROCKER SCIENTIFIC / TAIWAN
TI170214-22	DRY125	Electronic Dry Cabinet , 141 Litres External : 440 x 440 x 930mm (WxDxH) Internal : 438 x 385 x 850mm (WxDxH) Shelf : 3	unit	ROCKER SCIENTIFIC / TAIWAN
TI170215-22	DRY230	Electronic Dry Cabinet , 230 Litres External : 590 x 480 x 970mm (WxDxH) Internal : 588 x 425 x 900mm (WxDxH) Shelf : 3	unit	ROCKER SCIENTIFIC / TAIWAN
TI170216-22	DRY190	Electronic Dry Cabinet , 195Litres External : 806 x 480 x 660mm (WxDxH) Internal : 804 x 420 x 580mm (WxDxH) Shelf : 2	unit	ROCKER SCIENTIFIC / TAIWAN
TI170217-22	DRY205	Electronic Dry Cabinet , 228 Litres External : 400 x 530 x 1280mm (WxDxH) Internal : 398 x 475 x 1210mm (WxDxH) Shelf : 5	unit	ROCKER SCIENTIFIC / TAIWAN
TI170218-22	DRY300	Electronic Dry Cabinet , 320 Litres External : 890 x 480 x 930mm (WxDxH) Internal : 888 x 425 x 850mm (WxDxH) Shelf : 3	unit	ROCKER SCIENTIFIC / TAIWAN
TI170219-22	DRY420	Electronic Dry Cabinet , 450 Litres External : 11800 x 480 x 1020mm (WxDxH) Internal : 1178 x 425 x 900mm (WxDxH) Shelf : 3	unit	ROCKER SCIENTIFIC / TAIWAN

TI170220-22	DRY520	Electronic Dry Cabinet , 545 Litres External : 1180 x 570 x 1020mm (WxDxH) Internal : 1178 x 515 x 900mm (WxDxH) Shelf : 3	unit	ROCKER SCIENTIFIC / TAIWAN
TI170221-22	DRY610	Electronic Dry Cabinet ,646 Litres External : 1400 x 600 x 1000mm (WxDxH) Internal : 1398 x 545 x 850mm (WxDxH) Shelf : 3	unit	ROCKER SCIENTIFIC / TAIWAN
TI170222-22	DRY530	Electronic Dry Cabinet , 578 Litres External : 890 x 660 x 1190mm (WxDxH) Internal : 888 x 610 x 1070mm (WxDxH) Shelf : 6	unit	ROCKER SCIENTIFIC / TAIWAN
TI170223-22	DRY460	Electronic Dry Cabinet , 460 Litres External : 600 x 730 x 1240mm (WxDxH) Internal : 598 x 675 x 1160mm (WxDxH) Shelf : 3	unit	ROCKER SCIENTIFIC / TAIWAN
TI170224-22	DRY700	Electronic Dry Cabinet , 700 Litres External : 600 x 730 x 1950mm (WxDxH) Internal : 598 x 675 x 1800mm (WxDxH) Shelf : 5	unit	ROCKER SCIENTIFIC / TAIWAN
TI170225-22	DRY1360	Electronic Dry Cabinet , 1402 Litres External : 1200 x 730 x 1950mm (WxDxH) Internal : 1198 x 675 x 1800mm (WxDxH) Shelf : 5	unit	ROCKER SCIENTIFIC / TAIWAN
TI170226-22	DRY1460	Electronic Dry Cabinet , 1460 Litres External : 1200 x 730 x 1960mm (WxDxH) Internal : 1198 x 677 x 1805mm (WxDxH) Shelf : 5	unit	ROCKER SCIENTIFIC / TAIWAN
TI170228-22	DRY150V3	Electronic Dry Cabinet DRY , 150 Litres External : 460 x 650 x 710mm (WxDxH) Internal : 380 x 520 x 150mm (WxDxH) x 3 Drawer : 3	unit	ROCKER SCIENTIFIC / TAIWAN
TI170229-22	DRY200V4	Electronic Dry Cabinet , 200 Litres External : 460 x 650 x 890mm (WxDxH) Internal : 380 x 520 x 150mm (WxDxH) x 4 Drawer : 4	unit	ROCKER SCIENTIFIC / TAIWAN
TI170230-22	DRY250V5	Electronic Dry Cabinet , 250 Litres External : 460 x 650 x 1070mm (WxDxH) Internal : 380 x 520 x 150mm (WxDxH) x 5 Drawer : 5	unit	ROCKER SCIENTIFIC / TAIWAN
TI170231-22	DRY160H2	Electronic Dry Cabinet , 160 Litres External : 460 x 650 x 750mm (WxDxH) Internal : 380 x 520 x 270mm (WxDxH) x 2 Drawer : 2	unit	ROCKER SCIENTIFIC / TAIWAN
TI170232-22	DRY240H3	Electronic Dry Cabinet , 240 Litres External : 460 x 650 x 1070mm (WxDxH) Internal : 380 x 520 x 270mm (WxDxH) x 3 Drawer : 3	unit	ROCKER SCIENTIFIC / TAIWAN
TI170233-22	DRY320H4	Electronic Dry Cabinet , 320 Litres Drawer Series External : 460 x 650 x 1470mm (WxDxH) Internal : 380 x 520 x 270mm (WxDxH) x 4 Drawer : 4	unit	ROCKER SCIENTIFIC / TAIWAN
TI170235-22	DRY500V5	Electronic Dry Cabinet , 500 Litres External : 890 x 650 x 1150mm (WxDxH) Internal : 810 x 520 x 150mm (WxDxH) x 5 Drawer : 5	unit	ROCKER SCIENTIFIC / TAIWAN

TI170236-22	DRY720V5	Electronic Dry Cabinet , 720 Litres External : 1000 x 750 x 1150mm (WxDxH) Internal : 920 x 620 x 150mm (WxDxH) x 5 Drawer : 5	unit	ROCKER SCIENTIFIC / TAIWAN
TI170238-22	DRY310W	Electronic Dry Cabinet DRY-310W, 312 Litres Classic Series with Wood Door External : 900 x 540 x 920mm (WxDxH) Internal : 865 x 460 x 790mm (WxDxH) Shelf : 4	unit	ROCKER SCIENTIFIC / TAIWAN
TI170237-22	DRY310GW	Electronic Dry Cabinet , 312 Litres Classic Series with Glass Door & Wood Frame External : 900 x 540 x 920mm (WxDxH) Internal : 865 x 460 x 790mm (WxDxH) Shelf : 4	unit	ROCKER SCIENTIFIC / TAIWAN
TI177300-22	Dragon 300	Electric Sterilizer Temperature range : R.T. +20 to950°C Power : 180 watt Chamber diameter : Ø16mm	unit	ROCKER SCIENTIFIC / TAIWAN
TI177320-22	Dragon 320	Electric Sterilizer Temperature range : R.T. +20 to950°C Power : 180 watt Chamber diameter : Ø37mm	unit	ROCKER SCIENTIFIC / TAIWAN
TI177300-02		Heater for Dragon 300,AC220V	unit	ROCKER SCIENTIFIC / TAIWAN
TI177320-02		Heater for Dragon 320,AC220V	unit	ROCKER SCIENTIFIC / TAIWAN

Testers

SENZ PAL series

Water resistant; Drop-shock; Auto-shut off; Low battery alert (In rigid plastic packaging box)

Catalogue No.	Description
TR-SZPH	Senz pH , Range: 0 to 14 pH, Resolution: 0.1pH
TR-SZPHPRO	Senz pH Pro, Range: 0.00 to 14.00 pH, Resolution:0.01 pH
TR-SZPHDUO	Senz pH Duo (pH & Temperature) , Range: 0.00 to 14.00 pH , 0 to 50°C , Resolution: 0.1 pH / 0.1C
TR-SZRDX	Senz REDOX , Range: ± 999 mV, Resolution: 1 mV
TR-SZTDS	Senz TDS , Range:10 to 1,990 ppm, Resolution: 10 ppm
TR-SZTDS-2	Senz TDS , Range:100 to 10,000 ppm, Resolution: 100 ppm
TR-uSiemen	Senz TDS , Range:10 to 1990 µS, Resolution: 10 µS
TR-mSiemen	Senz TDS , Range: 0.1 to 19.9 mS, Resolution: 0.1mS

Litecheck series

Water resistant; Drop-shock; Auto-shut off; Low battery alert (In rigid plastic packaging box)

Catalogue No.	Description
TR-ALX	Aqua lite check, Range: 100 to 50,000 Lux, Resolution: 100LUX
TR-ECLX	Eye care check, Range: 10 to 5,000 LUX, Resolution: 10LUX
TR-HLX	Hortichack, Range: 100 to 50,000 Lux ,Resolution: 100Lux
TR-TSLX	Tint Screen check, Range:100 to 20,000 Lux, Resolution: 100Lux

AQUA PAL series

Catalogue No.	Description
TR-PHPAL	PH PAL , Resolution: 0.01pH
TR-TDS1	Range: 10 to 1,990 ppm, Resolution: 10 ppm
TR-TDS2	Range: 100 to 10,000 ppm, Resolution: 100 ppm
TR-TDS3	Range: 10 to 1,990 µS, Resolution: 10 µs
TR-TDS4	Range: 100 to 19,900 µS, Resolution: 100 µS
TR-WATERPAL	Range: 0 to 800 ppm, Resolution: 1 ppm

Meter

WalkLab Meters (basic Range)

Complete with Electrode / Probe, calibration solution in carrying bag

Catalogue No.	Description
TR-TI9000	WalkLAB Microprocessor pH meter TI9000 (Portable Microprocessor — pH, mV, Temperature Meter) Range:0 to 14 pH, Display Resolution: 0.01pH
TR-CONPRO	WalkLAB Digital Conductivity Pro Meter (Portable Wide-range Digital Conductivity Meter)
TR-DO-1	WalkLAB Digital Dissolved Oxygen Meter With 1meter probe (Portable Digital Dissolved Oxygen Meter) Range: 0 - 20 mg/L, Display resolution: 0.1 mg/L
TR-DO-2	WalkLAB Digital Dissolved Oxygen Meter With 2meter probe (Portable Digital Dissolved Oxygen Meter) Range: 0 - 20 mg/L, Display resolution: 0.1 mg/L
TR-DO-3	WalkLAB Digital Dissolved Oxygen Meter With 3meter probe (Portable Digital Dissolved Oxygen Meter) Range: 0 - 20 mg/L, Display resolution: 0.1 mg/L
TR-ELEC-DO-01	WalkLAB Digital Dissolved Oxygen Meter with 1meter cable(Portable Digital Dissolved Oxygen Meter) Range: 0 - 20 mg/L, Display resolution: 0.1 mg/L
TR-DYTMETER	Dialysate Meter
TR-ROMETER	R.O. Meter

Professional Handheld Meter

Complete with Electrode / Probe, calibration solution in hard carrying case

Catalogue No.	Description
TR-HC3010	Professional Portable Conductivity Meter HC3010
TR-HD3030	Professional Dissolved Oxygen Meter HD3030

Professional Bench Top Meter

Complete with electrode/Probe, electrode stand, box

Catalogue No.	Description
TR-BP3001	Professional Bench Top pH Meter BP3001
TR-BC3020	Professional Bench Top Conductivity Meter BC3020
TR-RS232	RS232 Software CDR & Cable

PH Buffer Solution

Catalogue No.	Description
TR-7010-90	pH 7.00
TR-4010-90	pH 4.01
TR-1010-90	pH 10.01

Electrode Filling Solution

Catalogue No.	Description
TR-2300-90	3m Kcl Ref. Electrode
TR-2350-90	3.5m Kcl Ref. Electrode
TR-2400-90	4m Kcl Ref. Electrode
TR-2174-50	D.O. Electrolyte (50ml bottle only)
TR-4230-90	pH Electrode Storage

Catalogue No.	Description	UOM	Brand
96.10686.08	Transferpette S Fix 10µl, Fixed Volume	unit	TREFFLAB/ SWITZERLAND
96.10686.16	Transferpette S Fix 20µl, Fixed Volume	unit	TREFFLAB/ SWITZERLAND
96.10686.20	Transferpette S Fix 25µl, Fixed Volume	unit	TREFFLAB/ SWITZERLAND
96.10686.28	Transferpette S Fix 50µl, Fixed Volume	unit	TREFFLAB/ SWITZERLAND
96.10686.38	Transferpette S Fix 100µl, Fixed Volume	unit	TREFFLAB/ SWITZERLAND
96.10686.44	Transferpette S Fix 200µl, Fixed Volume	unit	TREFFLAB/ SWITZERLAND
96.10686.54	Transferpette S Fix 500µl, Fixed Volume	unit	TREFFLAB/ SWITZERLAND
96.10686.62	Transferpette S Fix 1000µl, Fixed Volume	unit	TREFFLAB/ SWITZERLAND
96.10687.01	Transferpette S DIG 0.1 - 1µl, Variable Volume, Division : 0.005µl	unit	TREFFLAB/ SWITZERLAND
96.10687.02	Transferpette S DIG 0.5 - 10µl, Variable Volume, Division : 0.01µl	unit	TREFFLAB/ SWITZERLAND
96.10687.03	Transferpette S DIG 2 - 20µl, Variable Volume, Division : 0.01µl	unit	TREFFLAB/ SWITZERLAND
96.10687.74	Transferpette S DIG 10 - 100µl, Variable Volume, Division : 0.1µl	unit	TREFFLAB/ SWITZERLAND
96.10687.78	Transferpette S DIG 20 - 200µl, Variable Volume, Division : 1.0µl	unit	TREFFLAB/ SWITZERLAND
96.10687.80	Transferpette S DIG 100 - 1000µl, Variable Volume, Division : 1.0µl	unit	TREFFLAB/ SWITZERLAND
96.10687.82	Transferpette S DIG 0.5 - 5ml, Variable Volume, Division : 1.0µl	unit	TREFFLAB/ SWITZERLAND
96.10687.84	Transferpette S DIG 1 - 10ml, Variable Volume, Division : 1.0µl	unit	TREFFLAB/ SWITZERLAND
96.10688.00.1	8-Channel Transferpette S 8F 0.5 - 10µl, Division : 0.05µl	unit	TREFFLAB/ SWITZERLAND
96.10688.06.1	8-Channel Transferpette S 8F 5 - 50µl, Division : 0.1µl	unit	TREFFLAB/ SWITZERLAND
96.10688.08.1	8-Channel Transferpette S 8F 10 - 100µl, Division : 0.1µl	unit	TREFFLAB/ SWITZERLAND
96.10688.09.1	8-Channel Transferpette S 8F 20 - 200µl, Division : 1.0µl	unit	TREFFLAB/ SWITZERLAND
96.10688.10.1	8-Channel Transferpette S 8F 30 - 300µl, Division : 1.0µl	unit	TREFFLAB/ SWITZERLAND
96.10689.20.1	12-Channel Transferpette S 12F 0.5 - 10µl, Division : 0.05µl	unit	TREFFLAB/ SWITZERLAND
96.10689.26.1	12-Channel Transferpette S 12F 5 - 50µl, Division : 0.1µl	unit	TREFFLAB/ SWITZERLAND
96.10689.28.1	12-Channel Transferpette S 12F 10 - 100µl, Division : 0.1µl	unit	TREFFLAB/ SWITZERLAND
96.10689.29.1	12-Channel Transferpette S 12F 20 - 200µl, Division : 1.0µl	unit	TREFFLAB/ SWITZERLAND
96.10689.30.1	12-Channel Transferpette S 12F 30 - 300µl, Division : 1.0µl	unit	TREFFLAB/ SWITZERLAND
96.10703.01	Stand for Transferpette S	unit	TREFFLAB/ SWITZERLAND
96.9266.8.01	Wall-mounted stand for 3 Transferpettes	unit	TREFFLAB/ SWITZERLAND
96.9239.40	Stand for 1 Treff 8-Channel or 12-Channel Pipettes	unit	TREFFLAB/ SWITZERLAND
96.4343.9.01	Stand for 7 pipettes (For different pipette brands)- 7 Places	unit	TREFFLAB/ SWITZERLAND
96.4796.9.01	Reservoir 50ml, PP, Autoclavable for 8 & 12 Channel Pipette	unit	TREFFLAB/ SWITZERLAND
96.9918.08.1	8 Channel, 10 - 100µl, Division : 0.1µl (While Stock Last)	unit	TREFFLAB/ SWITZERLAND
96.9918.10.1	8 Channel, 30 - 300µl, Division : 1.0µl (While Stock Last)	unit	TREFFLAB/ SWITZERLAND
96.9920.26.1	12 Channel, 5 - 50µl, Division : 0.1µl (While Stock Last)	unit	TREFFLAB/ SWITZERLAND
96.9277.8.01	Stand for 6 Transferpettes (While Stock Last)	unit	TREFFLAB/ SWITZERLAND

Environment Line

Catalogue No.	Model	Description	UOM	Brand
VP-F10100120	ECO 6	Thermoreactor for C.O.D. 6 Position	unit	VELP/ ITALY
VP-F101A0127	ECO 8	Thermoreactor for C.O.D. 8 Position with safety cover	unit	VELP/ ITALY
VP-F10100126	ECO 16	Thermoreactor for C.O.D. 16 Position	unit	VELP/ ITALY
VP-F101A0125	ECO 25	Thermoreactor C.O.D. 25 Position with safety cover	unit	VELP/ ITALY
VP-F10220131	BMS6	BOD Determination Systems, BOD 6 places type BMS 6 (Traditional BOD analysis solution)	unit	VELP/ ITALY
VP-F102B0133	BOD Sensor	BOD Determination Systems, BOD Sensor	unit	VELP/ ITALY
VP-F102B0134	BOD Sensor Set	BOD Determination Systems, BOD. Sensor Set	unit	VELP/ ITALY
VP-F10220136	BOD S.System 6	BOD Determination Systems, Complete System for BOD Analysis Sensor System 6	unit	VELP/ ITALY
VP-F10220137	BOD S.System 10	BOD Determination Systems, Complete System for BOD Analysis Sensor System 10	unit	VELP/ ITALY
VP-F10300140	FTC 90	Refrigerating Incubator type FTC 90	unit	VELP/ ITALY
VP-F10300143	FTC 90E	Refrigerating Incubator type FTC 90E	unit	VELP/ ITALY
VP-F10400143	FTC 90I	Refrigerating Incubator type FTC 90I (With transparent	unit	VELP/ ITALY
VP-F10300170	FOC 225E	Refrigerating Incubator type FOC 225E	unit	VELP/ ITALY
VP-F10400160	FOC 225I	Refrigerating Incubator type FOC 225I (With transparent	unit	VELP/ ITALY
VP-F105A0108	JLT 4	Flocculator 4 places type JLT4	unit	VELP/ ITALY
VP-F105A0109	JLT 6	Flocculator 6 places type JLT6	unit	VELP/ ITALY
VP-F105A0111	FC4S	Flocculator 4 places (Individual speed selector for each stirrer)	unit	VELP/ ITALY
VP-F105A0112	FC6S	Flocculator 6 places (Individual speed selector for each stirrer)	unit	VELP/ ITALY
VP-F105A0117	FP4	Portable Flocculator type FP 4	unit	VELP/ ITALY
VP-F107C0146	TMD6	TMD6 Mineralization System 6 places	unit	VELP/ ITALY
VP-F10600118	ROTAX 6.8	Overhead Mixer type ROTAX 6.8	unit	VELP/ ITALY
VP-R109B12150	TB1	Turbidimeter type TB1	unit	VELP/ ITALY
VP-R10800340		Radiation Detector	unit	VELP/ ITALY

Pumps Line

Catalogue No.	Model	Description	UOM	Brand
VP-F40100541	JPV	JPV Recirculating water vacuum pump 230v/50-60hz	unit	VELP/ ITALY
VP-F40200002	SP311/2	Peristaltic pump 230v/50-60hz	unit	VELP/ ITALY
VP-F40200006	SP311/6	Peristaltic pump 230v/50-60hz	unit	VELP/ ITALY
VP-F40200012	SP311/12	Peristaltic pump 230v/50-60hz	unit	VELP/ ITALY
VP-F40200060	SP311/60	Peristaltic pump 230v/50-60hz	unit	VELP/ ITALY
VP-10001893		Accessories Pumps Line-Vacuum tube	unit	VELP/ ITALY
VP-10002042		Accessories Pumps Line - Silicone tube Ø 4x7mm	unit	VELP/ ITALY
VP-10001090		Accessories Pumps Line - Silicone tube Ø 5x8mm	unit	VELP/ ITALY

Stirring Line

Catalogue No.	Model	Description	UOM	Brand
VP-F20520162	ARE	Heating magnetic stirrer	unit	VELP/ ITALY
VP-F20500163	AREX	Heating magnetic stirrer	unit	VELP/ ITALY
VP-F20520169	ARED	High Power Heating Magnetic Stirrer	unit	VELP/ ITALY
VP-F20520170	T.ARE	High Power Heating Magnetic Stirrer With Timer	unit	VELP/ ITALY
VP-F20500100	HSC	Heating Magnetic Stirrer 230v/50-60hz	unit	VELP/ ITALY
VP-F20500010	AREC	Magnetic Stirrer With Ceramic Heating Plate	unit	VELP/ ITALY
VP-F20500060	AREC.X	Magnetic Stirrer With Ceramic Heating Plate	unit	VELP/ ITALY
VP-F20500050	AREC.T	Timed Magnetic Stirrer With Ceramic Heating Plate	unit	VELP/ ITALY
VP-F20520166	AM4	Multiple Heating Magnetic Stirrer	unit	VELP/ ITALY
VP-F208B0063	VTF	VTF Digital thermoregulator Fuzzy Logic Technology	unit	VELP/ ITALY
VP-F206A0179	ESP	ESP Magnetic stirrer without motor 100-240V/50-60Hz	unit	VELP/ ITALY
VP-F203A0160	MST Microstirrer	MST Magnetic stirrer 100-240V/50-60Hz	unit	VELP/ ITALY
VP-F203A0161	MST Microstirrer	MICROSTIRRER Magnetic stirrer 100-240V/50-60Hz	unit	VELP/ ITALY
VP-F20320164	AGE	Magnetic Stirrer	unit	VELP/ ITALY
VP-F20300165	ATE	Magnetic stirrer for High Power	unit	VELP/ ITALY
VP-F203A0177	Multistirrer 6	Multiposition Magnetic stirrer , up to 6 Beakers	unit	VELP/ ITALY
VP-F203A0178	Multistirrer 15	Multiposition Magnetic stirrer , up to 15 Beakers	unit	VELP/ ITALY
VP-F204A0167	AMI	Illuminated Magnetic stirrer, single position	unit	VELP/ ITALY
VP-F204A0168	AMI 4	Illuminated Magnetic stirrer, 4 separately controlled position	unit	VELP/ ITALY
VP-F20100152	ES	ES Overhead stirrer 230V/50-60Hz	unit	VELP/ ITALY
VP-F20100151	BS	BS Overhead stirrer 230V/50-60Hz	unit	VELP/ ITALY
VP-F20100155	DLS	DLS Overhead stirrer 230V/50-60Hz	unit	VELP/ ITALY
VP-F20100156	LH	LH Overhead stirrer 230V/50-60Hz	unit	VELP/ ITALY
VP-F20100157	DLH	DLH Overhead stirrer 230V/50-60Hz	unit	VELP/ ITALY
VP-F20100150	PW	PW Overhead stirrer 230V/50-60Hz	unit	VELP/ ITALY
VP-F20700174	RC	RC Heating plate 230V/50-60Hz, single position	unit	VELP/ ITALY
VP-F20700172	RC 2	RC2 Heating plate 230V/50-60Hz, two position	unit	VELP/ ITALY
VP-F20700080	REC	REC Ceramic Heating Plate 230V/50-60Hz	unit	VELP/ ITALY
VP-F20220176	ZX3	ZX3 Vortex Mixers	unit	VELP/ ITALY
VP-F20220171	RX3	RX3 Vortex Mixers	unit	VELP/ ITALY
VP-F202A0173	Vortex Classic	Vortex Classic	unit	VELP/ ITALY
VP-F202A0175	Vortex Wizard	Vortex Wizard (With infrared system)	unit	VELP/ ITALY
VP-F202A0230	WX Vortex	WX Vortex 100-240V/50-60Hz	unit	VELP/ ITALY
VP-R20900010	OV5	OV5 Homogenizer 230V/50Hz, Speed range: from 10000to30000rpm	unit	VELP/ ITALY

Dispenser



Catalogue No.	Model	Description	UOM	Brand
VL1605503		Genius Bottle Top Dispenser With Variable Volume, Recirculation Valve and Media- Specific Recalibration. Volume 0.25ml to 2.5ml, Graduation 0.05ml <i>(While Stock Last)</i>	unit	VITLAB / GERMANY
VL1605504		Genius Bottle Top Dispenser With Variable Volume, Recirculation Valve and Media- Specific Recalibration. Volume 0.5ml to 5ml, Graduation 0.10ml <i>(While Stock Last)</i>	unit	VITLAB / GERMANY
VL1605507		Genius Bottle Top Dispenser With Variable Volume, Recirculation Valve and Media- Specific Recalibration. Volume 5ml to 50ml, Graduation 1.0ml <i>(While Stock Last)</i>	unit	VITLAB / GERMANY
VL1605508		Genius Bottle Top Dispenser With Variable Volume, Recirculation Valve and Media- Specific Recalibration. Volume 10ml to 100ml, Graduation 2.0ml <i>(While Stock Last)</i>	unit	VITLAB / GERMANY

Rotary Evaporator

Catalogue No.	Model	Description	UOM	Brand
YMT255116	RE301A-O	<p>Rotary Evaporator RE301A-O</p> <ul style="list-style-type: none"> * Basic Type Controller * With Standard Use Glassware (Horizontal) * With An Oil Bath <p>Motor: DC Brushless Motor (for rotation) and Rod Actuator (for lifting)</p> <p>Rotation Speed : 20 to 250rpm (r/min)</p> <p>Lift Stroke : 130mm</p> <p>Safety measures (main unit) : Manual-setting lower limit, upper limit, motor overload</p> <p>External Dimension: With Glassware A: 828 x400x580mm (710mm(H) When Raised) Weight: Approx.14.1kg (Excluding The Glassware and The Oil Bath)</p> <p>Power Main Unit: 100 - 240V AC, 1.5A (Excluding The Oil Bath)</p>	unit	YAMATO / JAPAN

MISCELLANEOUS LABORATORY PRODUCTS

No.	Catalogue No.	Description
1	MX20011	RUBBER TEAT, Black
2	MX10010	RETORT STAND - Complete Set
3	MX10011	BOSS HEAD for Retort Stand
4	MX10012	CLAMP for Retort Stand
5	MX10013	BASE & ROD for Retort Stand
6	MX10021	BUNSEN BURNER
7	MX10022	TRIPOD STAND
8	MX10023	WIRE GAUZE
9	MX10034	LABORATORY JACK, Size 150 x 150 mm
10	MX10035	LABORATORY JACK, Size 200 x 200 mm
11	MX30011	DIGITAL TIMER

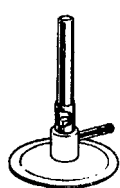

6



7

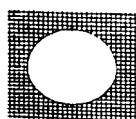

8

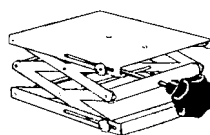

9,10



11



1



3

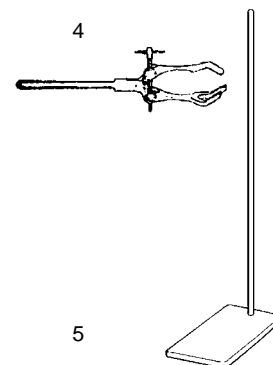

5

MISCELLANEOUS LABORATORY PRODUCTS

No.	Catalogue No.	Description
A1	MX10071	BURETTE CLAMP, METAL, Double Clamps
A2	MX10041	FORCEP with Sharp End, 5" (125 mm)
A3	MX10042	FORCEP with Blunt End, 5" (125 mm)
A4	MX10043	FORCEP with Curved End 5" (125mm)
A5	MX10052	SPATULA with One End Spoon, Stainless Steel, 200 mm Stainless Steel
A6	MX10053	Stainless Steel Spatula Chattaway Pattern 200mm
A7	MX10081	Draining Rack, Epoxy Coated, 104 Pegs Size : 630 x 540 mm
A8	PFM4X125	PARAFILM 4" x 125 FT, USA
A9	MXCH-SGEL	SILICA GEL (1kg)
A10	MX50011	SILICONE VACUUM GREASE, DOW CORNING (Tube of 150gm)

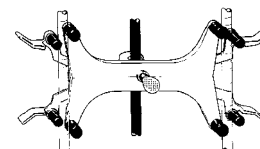

A1



A2, A3, A4



A5, A6

MISCELLANEOUS LABORATORY PRODUCTS

TEST TUBE BRUSH

A.J. COPE, U.K.

No.	Catalogue No.	Description
1	MX10061-45022	TEST TUBE BRUSH , Bristle Fan Shaped Head, 30mm Head Dia. Wire Handle. For 16 to 25 mm Tubes.
2	MX10061-45017	TEST TUBE BRUSH , Nylon Fan Shaped Head, 15mm Head Dia. Wire Handle. For 10 to 12 mm Tubes.
3	MX10061-45027	TEST TUBE BRUSH , Nylon Fan Shaped Head, 30mm Head Dia. Wire Handle. For 16 to 25 mm Tubes.
4	MX10061-45517	TEST TUBE BRUSH , Nylon Cotton-Tip Head, 16mm Head Dia. Wire Handle. For 12 to 16 mm Tubes.
5	MX10061-45527	TEST TUBE BRUSH , Nylon Cotton-Tip Head, 25mm Head Dia. Wire Handle. For 19 to 25 mm Tubes.
6	MX10062-40012	BEAKER BRUSH , Bristle Head, Wood Handle. 70mm Head Dia. 150mm Long. Overall Length 400mm.

* WHILE STOCK LAST

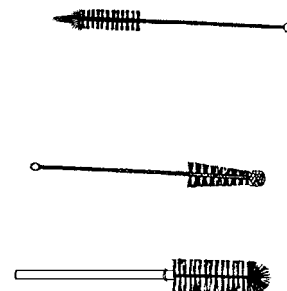

BOTTLE BRUSH

A.J. COPE, U.K.

No.	Catalogue No.	Description
1	MX10063-41022	BOTTLE BRUSH , Bristle Head, 50mm Head Dia., 75mm Long. Overall Length 350mm. Wire Handle. For 250ml Bottle.
2	MX10063-41017	BOTTLE BRUSH , Nylon Head, 45mm Head Dia., 65mm Long. Overall Length 300mm. Wire Handle. For 125ml Bottle.
3	MX10063-41027	BOTTLE BRUSH , Nylon Head, 50mm Head Dia., 75mm Long. Overall Length 350mm. Wire Handle. For 250ml Bottle.
4	MX10063-41037	BOTTLE BRUSH , Nylon Head, 65mm Head Dia., 100mm Long. Overall Length 400mm. Wire Handle. For 500ml Bottle.
5	MX10063-41047	BOTTLE BRUSH , Nylon Head, 75mm Head Dia., 150mm Long. Overall Length 460mm. Wire Handle. For 1000ml Bottle.

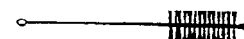

BURETTE BRUSH

A.J. COPE, U.K.

No.	Catalogue No.	Description
1	MX10064-42512	BURETTE BRUSH , Bristle Head, 13mm Head Dia.. Overall Length 500mm. Wire Handle. For 10ml Burette.
2	MX10064-42517	BURETTE BRUSH , Bristle Head, 16mm Head Dia.. Overall Length 600mm. Wire Handle. For 25ml Burette.
3	MX10064-42522	BURETTE BRUSH , Bristle Head, 19mm Head Dia.. Overall Length 750mm. Wire Handle. For 50ml Burette.
4	MX10065-43012	CYLINDER BRUSH , Nylon Fan Shaped End, 65mm Head Dia., 120mm Head Length. Overall Length 650mm. Wire Handle.
5	MX10065-43017	CYLINDER BRUSH , Nylon Fan Shaped End, 75mm Head Dia., 140mm Head Length. Overall Length 650mm. Wire Handle.

* ALL ITEM WHILE STOCK LAST

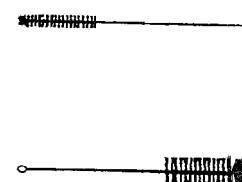

ZEAL, U.K.

HYDROMETERS	Catalogue Number	Range	Surface Tension
General Purpose	ZE-D3552	0.700 / 0.750	Low
50 Degree Range	ZE-D3553	0.750 / 0.800	Low
Subdivided 0.002	ZE-D3554	0.800 / 0.850	Low
230 mm length	ZE-D3555	0.850 / 0.900	Low
ZEAL , U.K.	ZE-D3556	0.900 / 0.950	Low
	ZE-D3557	0.950 / 1.000	Low
	ZE-D3558	1.000 / 1.050	Medium
	ZE-D3559	1.050 / 1.100	Medium
	ZE-D3560	1.100 / 1.150	Medium
	ZE-D3561	1.150 / 1.200	Medium
	ZE-D3562	1.200 / 1.250	Medium
	ZE-D3563	1.250 / 1.300	Medium
	ZE-D3564	1.300 / 1.350	Medium
	ZE-D3565	1.350 / 1.400	Medium
	ZE-D3566	1.400 / 1.450	Medium
	ZE-D3567	1.450 / 1.500	Medium

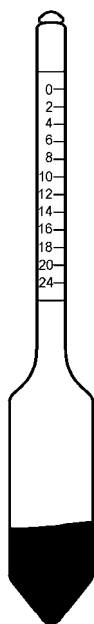

HYDROMETERS	Catalogue Number	Range	Surface Tension
General Purpose	ZE-D3578	0.600 / 0.700	Low
100 Degree Range	ZE-D3579	0.700 / 0.800	Low
Subdivided 0.005	ZE-D3580	0.800 / 0.900	Low
230 mm length	ZE-D3581	0.900 / 1.000	Low
ZEAL , U.K.	ZE-D3582	1.000 / 1.100	Medium
	ZE-D3583	1.100 / 1.200	Medium
	ZE-D3584	1.200 / 1.300	Medium
	ZE-D3585	1.300 / 1.400	Medium
	ZE-D3586	1.400 / 1.500	Medium
	ZE-D3587	1.500 / 1.600	Medium
	ZE-D3588	1.600 / 1.700	Medium

HYDROMETERS	Catalogue Number	Range	Surface Tension
Wide Scale	ZE-D3500	0.600 / 0.800	Low
200 Degree Sp. Gr. Range	ZE-D3501	0.800 / 1.000	Low
Subdivided 0.002	ZE-D3502	1.000 / 1.200	Medium
230 mm length	ZE-D3503	1.200 / 1.400	Medium
ZEAL , U.K.	ZE-D3504	1.400 / 1.600	Medium
	ZE-D3505	1.600 / 1.800	Medium
	ZE-D3506	1.800 / 2.000	Medium

HYDROMETERS	Catalogue Number	Range	Surface Tension
Wide Scale	ZE-D3510	0.700 / 1.000	L / M
300 Degree Sp. Gr. Range			
Subdivided 0.005			
230 mm length			
ZEAL , U.K.			

HYDROMETERS	Catalogue Number	Range	Surface Tension
Wide Scale	ZE-D3520	1.000 / 1.500	Medium
500 Degree Sp. Gr. Range	ZE-D3521	1.500 / 2.000	Medium
Subdivided 0.010			
240 mm length			

ZEAL , U.K.

HYDROMETERS	Catalogue Number	Range	Surface Tension
Wide Scale	ZE-D3530	1.000 / 2.000	Medium
1000 Degree Sp. Gr. Range		& 0 / 70 baume	
Subdivided 0.010			
305 mm length			

ZEAL , U.K.

ZEAL, U.K.

THERMOMETERS		Catalogue Number	Range	Division	Back Colour
General Purpose		ZE-L0100	-10 to +50°C	0.5	White
Mercury Filled		ZE-L0107	-10 to +50°C	0.5	Yellow
305 mm long		ZE-L0102	-10 to +110°C	1.0	White
76 mm immersion		ZE-L0109	-10 to +110°C	1.0	Yellow
ZEAL, U.K.		ZE-L0103	-10 to +150°C	1.0	White
		ZE-L0114	-10 to +150°C	1.0	Yellow
		ZE-L0104	-10 to +250°C	2.0	White
		ZE-L0110	-10 to +250°C	2.0	Yellow
		ZE-L0105	-10 to +360°C	2.0	White
		ZE-L0111	-10 to +360°C	2.0	Yellow
		ZE-L0101	-10 to +110°C	0.5	White
		ZE-L0108	-10 to +110°C	0.5	Yellow

THERMOMETERS		Catalogue Number	Range	Division	Spirit Colour
General Purpose		ZE-L0130	-10 to +50°C	0.5	Red
Spirit (Alcohol) Filled		ZE-L0131	-10 to +110°C	1.0	Red
305 mm long		ZE-L0132	-10 to +150°C	1.0	Red
76 mm immersion					
ZEAL, U.K. / ALLA, FRANCE					

THERMOMETERS		Catalogue Number	Range	Division
General Purpose		ZE-L0120	-10 to +50°C	1.0
Mercury Filled		ZE-L0121	-10 to +110°C	1.0
152 mm long				
total immersion				
ZEAL, U.K.				

THERMOMETER		Catalogue Number	Range	Division	Back Colour	Length mm
Precision Subdivided		ZE-L0503	-5 to +105°C	0.1	White	470
Mercury Filled						
total immersion						
engraved on scale						

ZEAL, U.K.

MAX/ MIN THERMOMETER		Catalogue Number	Range
		ZE-P3003	-30 to +50°C Mercury

WALL THERMOMETER		Catalogue Number	Length mm
Temperature Scale in °C/°F		ZE-P0501	-20/+50°C & °F
			225

ZEAL, U.K.

